

Mack Medium Duty Chassis PTO Installation

With the introduction of the Mack Medium Duty (MMD) Chassis January 4th, 2021, several PTO Installations have been revealed.

Contents

Option 1. Air Solenoid to Activate PTO	2
Option 2. PTO Dash Switch to control Cummins ECM PTO Relay	3
Option 3. PTO Dash Switch to Control Allison PTO Engagement Chassis Built Before May 19th, 2021, utilizing RLY16	8
Option 4. PTO Dash Switch to Control Allison PTO Engagement Chassis Built After May 19th, 2021, utilizing RLY6.....	10
Option 5. PTO Engine Speed Control with Signal from Allison PTO.....	13
Option 6. PTO Dash Switch to Control Allison 3000 Series PTO and Cummins Engine Interface Harness.....	20
Cummins Accelerator Interlock	21
CS6/8Series	23
Chelsea 272/282 Series PTO	24
Delphi 96 Way ECM Connector	25
Optional Cummins PTO Engine Speed Control and Programming	36
Alternate Operations such as SplitShaft PTO	37

Option 1. Air Solenoid to Activate PTO

The Standard PTO Offering is a PTO Switch and an Air Solenoid in the Air Solenoid Pack. See Figure 1.

This is to control an **Air Shifted PTO**. To use this Air Solenoid, remove the Solenoid Plug and install a length of ¼" Tubing to reach the PTO Shift Cylinder on the PTO.

Verify a PTO Switch is installed in the Dash if not order PTO Switch Part No. 22846105, remove Switch Panel, and install PTO Switch then connect the PTO Switch Connector. See figure 2



Figure 1 PTO Air Solenoid

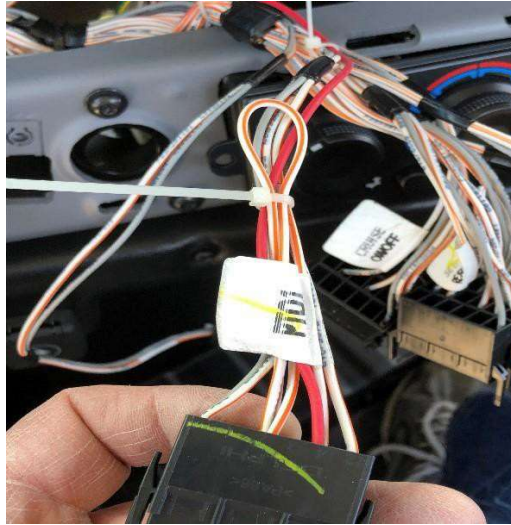

Figure 2 PTO Switch Connector

Note: When using an Air Shift to engage PTO the Transmission must be Placed in gear before activating the PTO Switch. The VECU Does not control Engine Speed whenever the PTO Switch is Activated. Verify with PTO Manufacturer Installation Instructions.

Option 2. PTO Dash Switch to control Cummins ECM PTO Relay for Engine Speed Control Only

This option will utilize the Dash mounted PTO switch to control the Cummins PTO Relay. No PTO Engagement

Required Parts List

Qty	Description	Mack Part No.	Cummins Part No.
2	Relay with Connector	Obtain Locally	
1	Size 16 Terminal Socket	20501086	
1	Roll Harness Tape	20469544	
2	ECM Connector Pigtail		2892507
As Needed	18 AWG [0.8 MWG] Stranded Wire	Obtain Locally	

- Turn off Battery Main Disconnect Switch or disconnect the Batteries Negative Terminal first.
- Find a suitable location in the engine bay close to the ECM and mount a weather sealed relay.
- Locate the 128-way MCFC connector on engine bay side of the bulkhead.
- Using the correct socket remove the 128-way MCFC connector.
- Locate terminal 114 and remove the corresponding Wedgelock assembly.

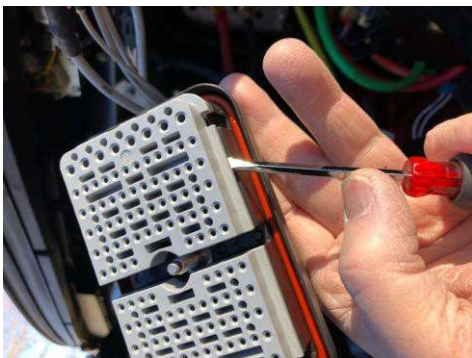

- Gently release the locking tab and remove terminal from cavity 114. Reference Figure 3
 - Heat shrink and tape the terminal to the harness you will not need it.
 - Take a piece of wire long enough to reach from the connector to the relay and on one end crimp terminal 20501086.
 - Insert that terminal into cavity 114 making sure it is fully seated reinstall the wedge lock and connect the MCFC Plug Connector and torque the retaining bolt to 30-35 IN-LB (3.38-3.95 N.M).
- On the other end of the wire connect to relay terminal 85. Using the Harness Tape, secure this wire to the front chassis harness.
 - Find a good spot for the relay ground and Make a Relay Ground Wire by Installing a Terminal for the wire going to Sealed Relay Terminal 86 and insert, install a Ring Terminal on end of this wire and connect to a good ground like the Mounting bolt used to mount the relay.
 - To make the Cummins ECU wires take 2 lengths of 18ga wire to reach from the Relay to the Cummins ECM J2 Connector (Reference Figure 4. Disconnect the Batteries Negative first or turn off the Master battery Disconnect Switch is so equipped.
 - Remove the Cummins J2 Connector reference Figure 5.
 - If equipped, fold back the Dust Boot back to gain access to the ECM Connector and remove the ECM Connector backshell by pressing in on the backshell locking tab and pivot the front of the backshell upwards, then pull the backshell forward, then upwards to release the backshell mounting tabs from the connector.

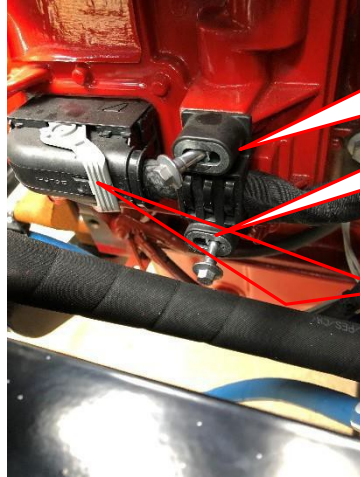

Remove these 2 bolts

Press down on the locking tab and pull up on the lever.

Note Do NOT close the lever after the connector has been removed from the ECM. Attempting to do so will cause damage.

- Gently release the Locking Comb by using retainer removal tool, Cummins part No. 4918919 to separate the locking comb from the connector body and fully remove the locking comb by hand.
- Locate Cavity 94 in the Cummins ECM J2 Connector, Reference Figure 6. Remove the seal plug from the J2 Connector.

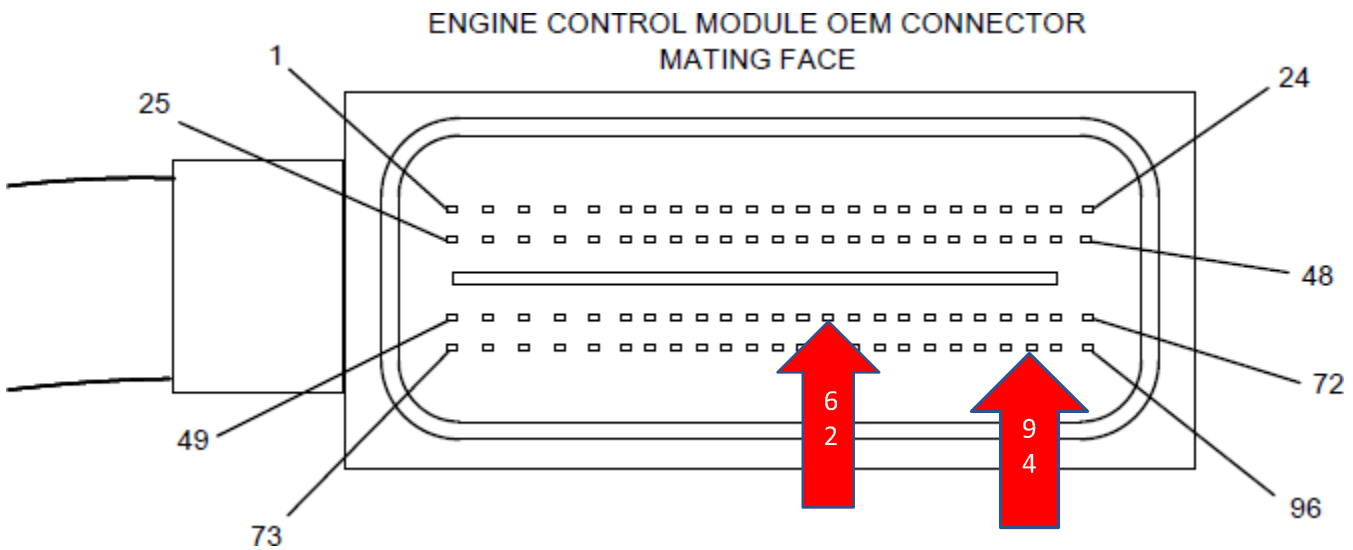

Figure 6 Cummins J2 OEM Connector

- Strip approximately 1" and crimp one end of a 18gq wire into the Cummins Connector Pigtail Part No. 2892507 and insert the terminal into cavity 94. The wire terminals have a locating feature that only allow the terminal to be inserted in one orientation. Insert the wire from the top of the connector as the other wires. Push the wire into the connector until the terminal locks into place, pull on the wire gently to make sure the terminal is locked into the connector.
- Locate and Remove the Terminal from Cavity 62 of the Cummins J2 Connector using Terminal Removal tool Cummins Part No. 4918921 into the larger access cavity. With the beveled side of the tool facing away from the terminal cavity slightly rotate the tool to release the terminal from the locking tang.

- Carefully pull the wire from the connector. If it is difficult to remove, repeat this entire process. If the wire is difficult to remove, DO NOT pull hard on the wire, otherwise, the locking tang of the terminal will stick, or the terminal will pull off the wire and remain in the connector body.
- Locate a good location to cut the terminal off the wire **you removed** from cavity 62 and strip approximately 1" of insulation off that wire and strip approximately 1" of insulation off the wire the wire to go to the PTO Relay.
- Insert these 2 wires into the supplied Butt Connector on Pigtail 2892507 and crimp with Cummins Wire Crimping Tool Part No. 3163109. Using a Heat Gun Cummins Part No. 3822860 or equivalent heat the shrink tubing around the wire.
- Insert the Terminal of Cummins Pigtail Part No. 2892507 into cavity 62 of the J2 Connector, verify the terminals are locked into the connector and carefully reinsert the Locking Comb. (The Locking comb should slide into the connector without excessive force. If it is difficult to install the locking comb, check to verify all the terminals are fully lock into the connector.) Install the backshell onto the connector, **NOTE** Make sure the lever on the back shell is in the open position before installing the backshell onto the connector.
- Position the wire bundle into place Position, install the backshell mounting tabs into the connector body and pivot the front of the backshell downward until the locking tab engages with the connector body. Install a wire tie to secure the wire bundle to the connector backshell. Reinstall the Hold down clamp to the Wiring harness bundle with wire ties (leave loose). Reinstall the J2 Connector into the ECM J2 Connector Opening and secure the lock lever. Reinstall the hold down bolts and torque to Cummins Specifications 71 in-lb. [8nm] then pull the wire ties tight and trim excess off.
- On the free end of these wires from the J2 Connector Cavities 62 and 94 will be inserted into the Cummins PTO Relay terminals 30 and 87 reference figure 7.
- Using the Harness Tape, tape the wires from the Cummins PTO Relay to the Cummins ECM J2 Connector to the existing wiring harness.
- If the Lock comb gets damaged a new part is available thru the Cummins Parts Department Part No. 4918926
- After connecting the wires from the Cummins ECM J2 Connector to the PTO Relay. The Cummins ECM will require programming.
- Using Cummins INSITE Software and Cummins Recommended Interface Adapter connect to the Green 9 Pin Diagnostic Connector located to the left of the Steering Column.
- Here is how your PTO should be set up for Remote PTO. if while using the PTO, the vehicle will be stationary. Reference Figure 8
- Set the Number of Engine Speeds and set each Set Speed as required. Using the Cummins Hardwired switch input make sure the circled item is set this way. After Programming the following will occur when PTO Switch is turned on.
- The Engine Speed will jump to 1000 RPM and the PTO Icon in the Dash Cluster Tachometer Reference Figure 9.

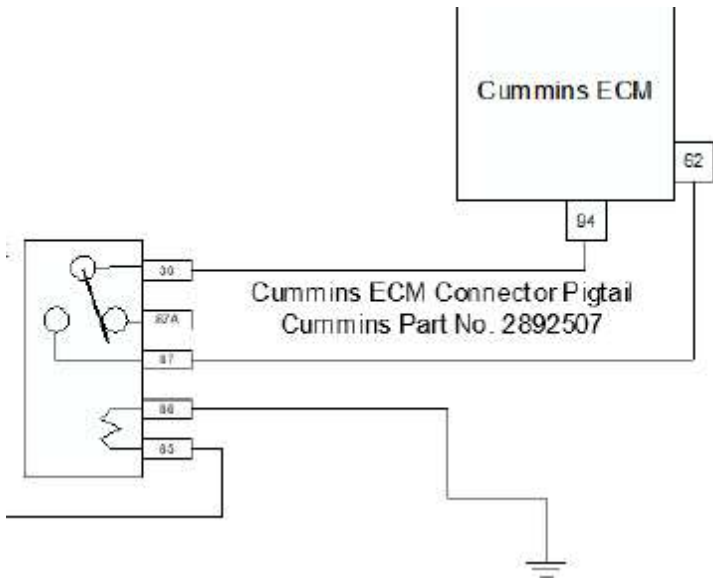





Figure 7 Cummins PTO Relay

Features and Parameters	ECM Value	Units
<input checked="" type="checkbox"/> Parking Brake Switch	Enable	
<input checked="" type="checkbox"/> Powertrain Protection	Disable	
<input checked="" type="checkbox"/> PTO	Enable	
\ Additional Switch Speed	950	RPM
\ Maximum Engine Load	800	ft*lb
\ Maximum Speed	2400	RPM
\ Maximum Vehicle Speed	6	mph
\ Minimum Speed	700	RPM
\ Ramp Rate	250	rpm/s
\ Resume Switch Speed	950	RPM
\ Set Switch Speed	950	RPM
\ PTO Speed 1 Device		
\ PTO Speed 2 Device		
\ PTO Speed 3 Device		
\ PTO Speed 4 Device		
\ PTO Speed 5 Device		
\ PTO Speed 6 Device		
\ PTO Speed 7 Device		
\ PTO Speed 8 Device		
<input checked="" type="checkbox"/> Accelerator Pedal or Lever Override	Disable	
<input checked="" type="checkbox"/> Alternate Operation	Disable	
<input checked="" type="checkbox"/> Cab PTO	Enable	
<input checked="" type="checkbox"/> Clutch Override	Disable	
<input checked="" type="checkbox"/> Ignore Vehicle Speed Source in PTO	Disable	
<input checked="" type="checkbox"/> Parking Brake Interlock Type	None	
<input checked="" type="checkbox"/> PTO Pump Mode	Disable	
<input checked="" type="checkbox"/> Remote PTO	Enable	
<input checked="" type="checkbox"/> Number of Speeds	1	
\ Sol Speed 1	1000	RPM
<input checked="" type="checkbox"/> Remote PTO Service Brake and Clutch Override	Disable	
<input checked="" type="checkbox"/> Remote Station PTO	Disable	
<input checked="" type="checkbox"/> Service Brake Override	Enable	
<input checked="" type="checkbox"/> Transmission Driven PTO	Disable	
<input checked="" type="checkbox"/> Transmission Neutral Interlock	Disable	
<input checked="" type="checkbox"/> Zero Vehicle Speed Source Limit	Disable	

Figure 8 PTO Settings

Note: Under SAE J1939 Multiplexing make sure PTO Options are disabled

	PTO On/Off Switch		Disable	
	PTO Resume Switch		Disable	
	PTO Set Switch		Disable	
	Remote Accelerator Position/Remote Accelerator Switch		Disable	
	Remote PTO Switch		Disable	

Set the Number of Engine Speeds and set each Set Speed as required. Using the Cummins Hardwired switch input make sure the circled item is set this way. After Programming the following will occur when PTO Switch is turned on. The Engine Speed will jump to 1000 RPM and the PTO Icon in the Dash Cluster Tachometer Reference Figure 9.



Figure 9 PTO Icon Illuminated in Tachometer

Option 3. PTO Dash Switch to Control Allison PTO Engagement

Chassis Built Before May 19th, 2021, utilizing RLY16

Chelsea offers a Powershift PTOs for the Allison 2000 / 2500 Series Transmission, Example 272-G-B-HV-P-B-5-RK

See Reference Material for breakdown of the Chelsea PTO Model

Muncie Power also offers a Clutch Shift PTO for the Allison 2000 Series Transmission, Example CS-6B-A67-03-S-1-B-P

See Reference Material for breakdown of the Muncie Power PTO Model

Regardless of which PTO is installed the Wiring will be the same.

Required Parts List

Qty	Description	Mack Part No.
2	Relay	Obtain Locally
2	Relay Connector	20865681
2	Relay Connector Lock	25154889
8	Terminals for Relay Connector	20865693
3	Terminals for Allison BB Connector	7526-12084912
As Needed	18 AWG [0.8 MWG] Stranded Wire	Obtain Locally
	Heat Shrink as needed	Obtain Locally
1	Roll Harness Tape	20469544
1	PTO Switch Connector Terminal	(1P) 20864201

Remove the 3 screws retaining the Fuse Relay Center (FRC) cover on top of the Dashboard. Locate Relay 16 in the Fuse Relay Center and remove it. Make up a 3" ~ 4" jumper using 18ga wire and install terminals 25106697 on each end, plug into RLY16 Cavities 30 and 85. Reference Figure 10

Locate the Allison BB Connector behind the Pedal Cover Reference Figure 11. Remove the Mating Connector and set aside. Using the wiring schematic in Figure 12 Wire the Relays into the Allison BB Connector.



Figure 11 Allison BB Connector

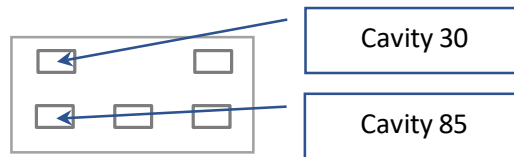

Figure 10 FRC Relay 16 Cavities in FRC

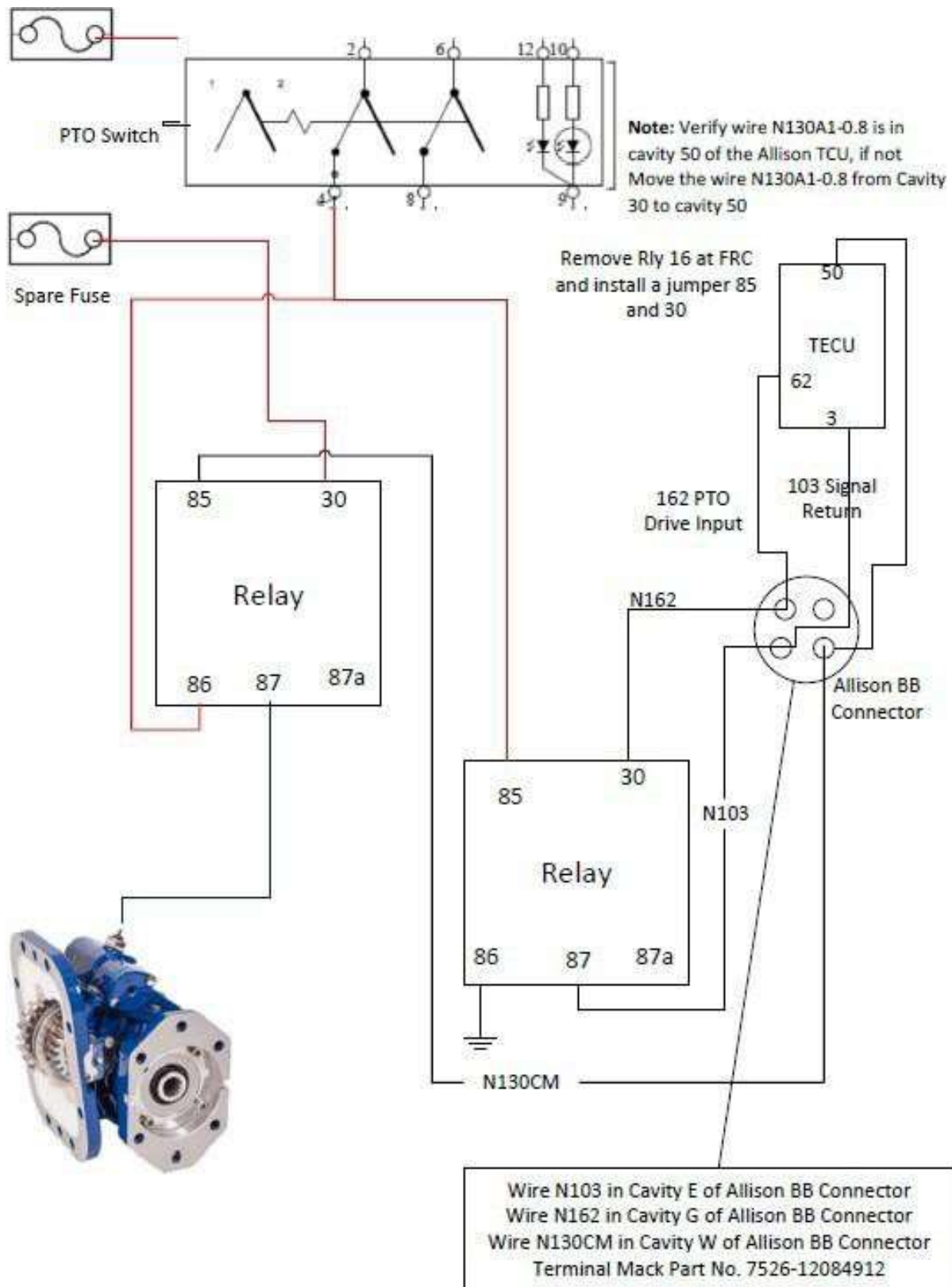

Figure 12

Option 4. PTO Dash Switch to Control Allison PTO Engagement Chassis Built After May 19th, 2021, utilizing RLY6

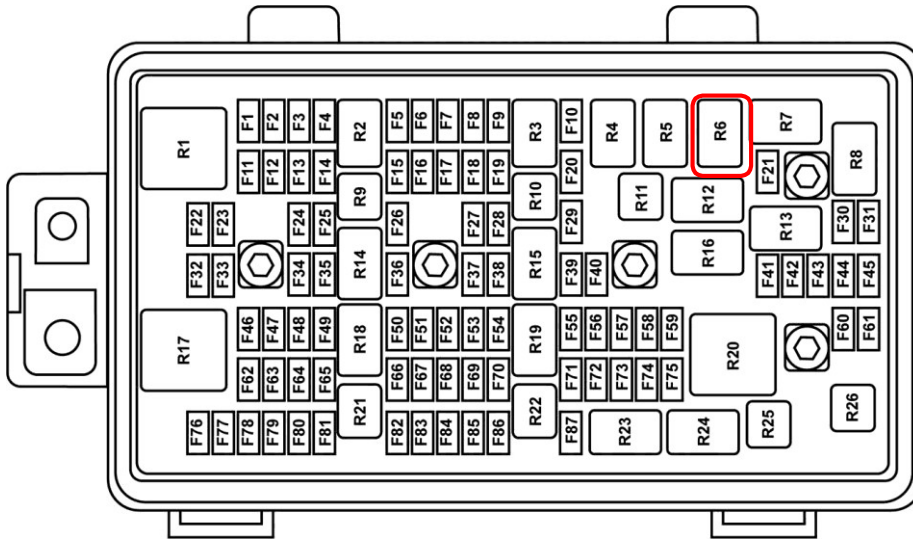

Figure 13 Fuse Relay Center (FRC)

Beginning MAY 19th with VIN 002786 Mack MMD Chassis switched to Relay 6 (R6) in Figure 13 for Allison Bodybuilder PTO Enable.

Required Parts List

Qty	Description	Mack Part No.
1	Relay	Obtain Locally
1	Relay Connector	20865681
1	Relay Connector Lock	25154889
4	Terminals for Relay Connector	20865693
4	Terminals for Allison BB Connector	7526-12084912
1	PTO Switch Connector Terminal	(1P) 20864201
As Needed	18 AWG [0.8 MWG] Stranded Wire	Obtain Locally
1	Heat Shrink as needed	Obtain Locally
1	Roll Harness Tape	20469544

Reference Figure 14 Below to wire in a Relay controlled by the Dash PTO Switch.

1. Crimp a (1P) 20864201 Terminal onto the end of 16 or 18 AWG wire and insert it into the PTO Switch Connector Cavity 4 route this wire down to the Allison BB Connector Reference Figure 11 in Option 3,
2. Crimp a Terminal 7526-12084912 onto an 8" length of 18 AWG wire and insert it into the Allison Body Builder Connector Mating Connector Cavity W.
3. Take these two wires and crimp a 20865693 Terminal onto the ends and insert into the Relay Connector Cavity for Terminal 85, As shown by the orange wire.
4. Crimp a Terminal 7526-12084912 onto an 8" length of 18 AWG wire and insert it into the Allison Body Builder Connector Mating Connector Cavity G, crimp a Terminal 20865693 on the other end of this wire and insert into the Relay Connector Cavity for Terminal 30. Wire ID N162 Allison PTO Drive Input
5. Crimp a Terminal 7526-12084912 onto an 8" length of 18 AWG wire and insert it into the Allison Body Builder Connector Mating Connector Cavity E, crimp a Terminal 20865693 on the other end of this wire and insert into the Relay Connector Cavity for Terminal 87. Wire ID N103 Allison Signal Return
6. Crimp a 20865693 Terminal onto a wire long enough to go from the Relay to a Good Cab Ground insert the

terminal into the Relay Connector Cavity for Terminal 86

7. Crimp a 7526-12084912 Terminal onto a length of wire long enough to reach an open cavity of the Allison Bulkhead Connector. Insert this terminal into Cavity M of the Allison BB Connector (Wire shown in Figure 10 as Burgundy) This wire will activate the Solenoid on the PTO.
8. The Completed Wiring should look like Figure 15, Connect the Allison BB Connector to the Main Cab Harness Allison BB Connector and secure the relay to the Allison BB Connector Cab harness using Tie Wrap.

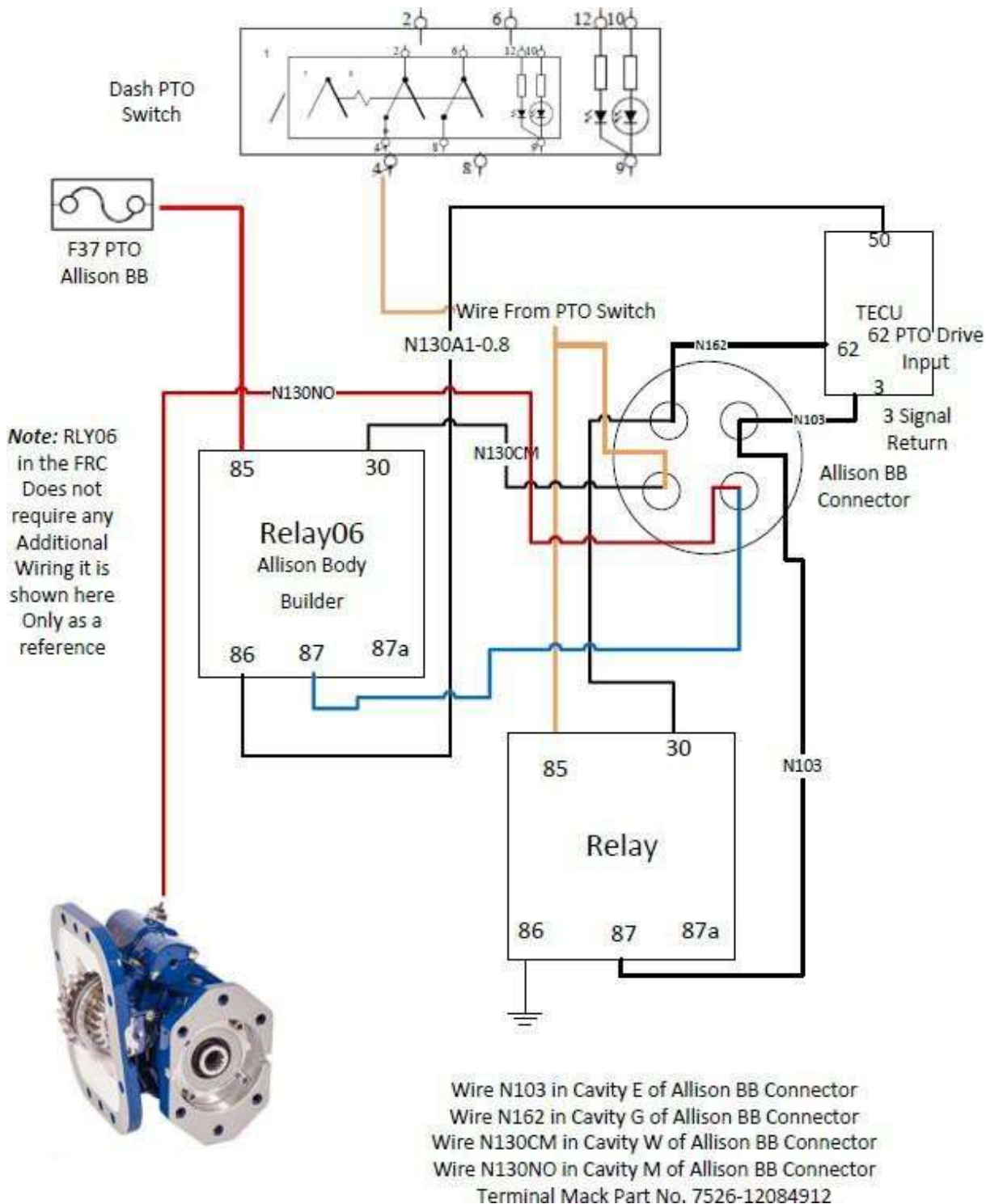

Figure 14 Allison Body Builder Circuit PTO

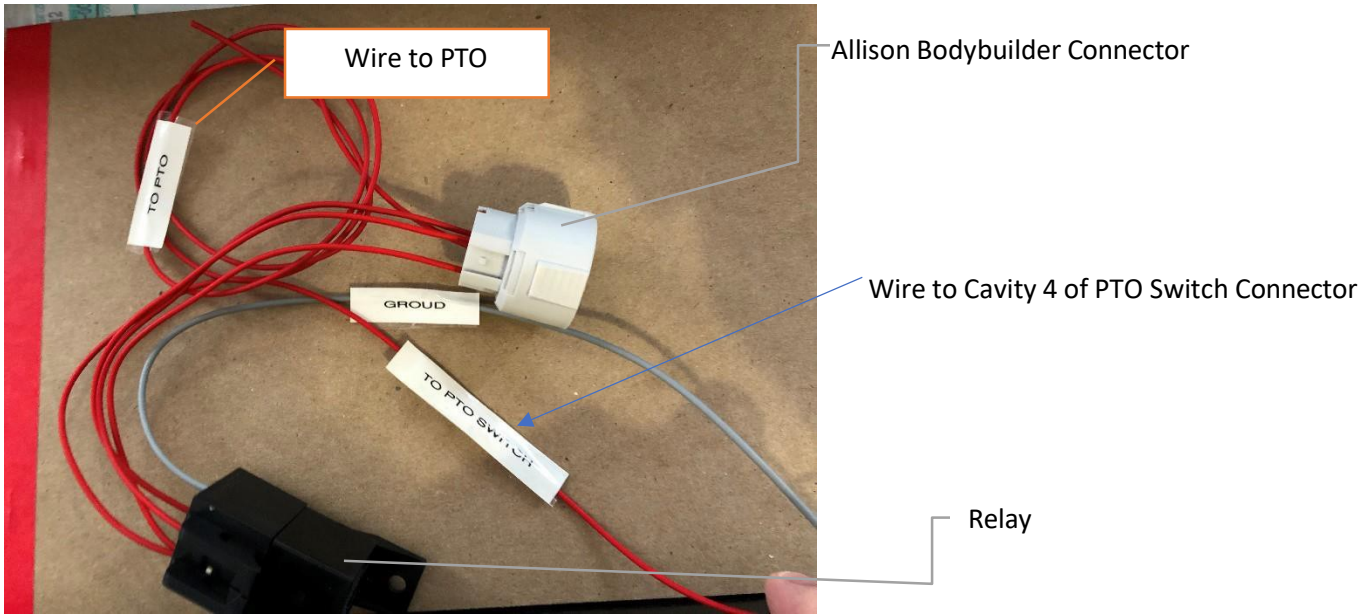

Figure 15 Allison BB Connector and Relay Wiring

WIRE ID	Cavity
N103	5
N162	7
N130CM	20
N130NO	12



T3183667

Fig. 6 New style MCBB Connector (Trucks built after 6/2022) Part #3987483 Terminal #978295



T3183668

Fig. 7 Old style X06D connector Part #20897253 Terminal #7526-12084912

Wire numbers will be the same between the connectors, but the new connector has pin numbers instead of letters.

Option 5. PTO Engine Speed Control with Signal from Allison PTO

Engine Speed Control for the PTO Pressure Switch activation will be handled by the Cummins ECM which requires wiring a relay in to activate the Cummins PTO Circuit. See Figure 16

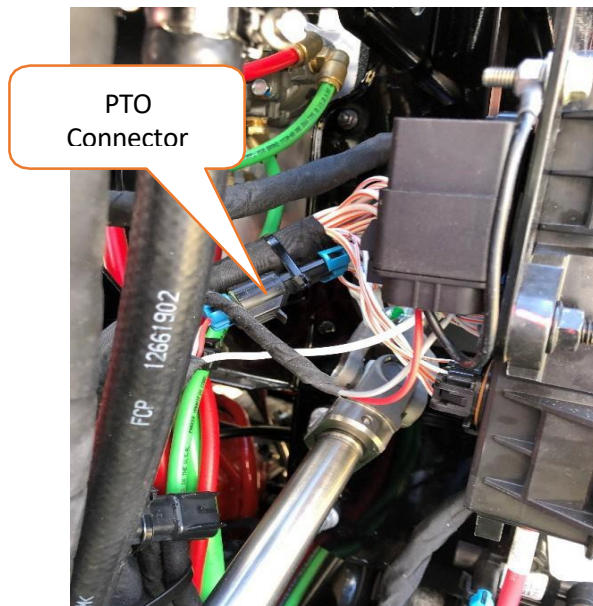

- Required Parts list**

Qty	Description	Mack Part No.	Cummins Part No.
1	Connector Male Terminal	8397382	
1	Connector Female Terminal	8397384	
2	Terminals	25088528	
2	Terminals	25014495	
4	Wire Seals	25088933	
1	Secondary Lock (TPA)	20865655	
As Needed	18 AWG [0.8 MWG] Stranded Wire	Obtain Locally	
As Needed	Heat Shrink as needed	Obtain Locally	
1	Roll Harness Tape	20469544	

- Make up a jumper harness to control the Cummins PTO Relay as follows.
- Cut a 4" length of 18 AWG wire and install a seal on each end of the wire, then strip a ¼" of insulation.
- Install a Male Terminal on one end and crimp using the appropriate crimping tool.
- Install a Female Terminal on the other end and crimp using the appropriate crimping tool.
- Insert this Jumper into Cavity "B" of both Connectors.
- Cut another 4" length of 18 AWG wire and install a seal on one end of the wire, then strip a ¼" of insulation.
- Near the center of this wire strip approximately ½" of insulation and take another length of 18 AWG wire long enough to go to the Relay to control the Cummins PTO Circuit Input, Terminal 85
- Strip off approximately ½" of insulation and wrap around the center of the jumper wire and solder this connection and cover with Sealant type Heat Shrink Tubing.
- Install the seal and the Male and Female Terminals and crimp using the appropriate crimping tool
- Insert the terminals into the Connectors Cavity "A" Reference Figure 16 and Figure 17 Wiring Diagram

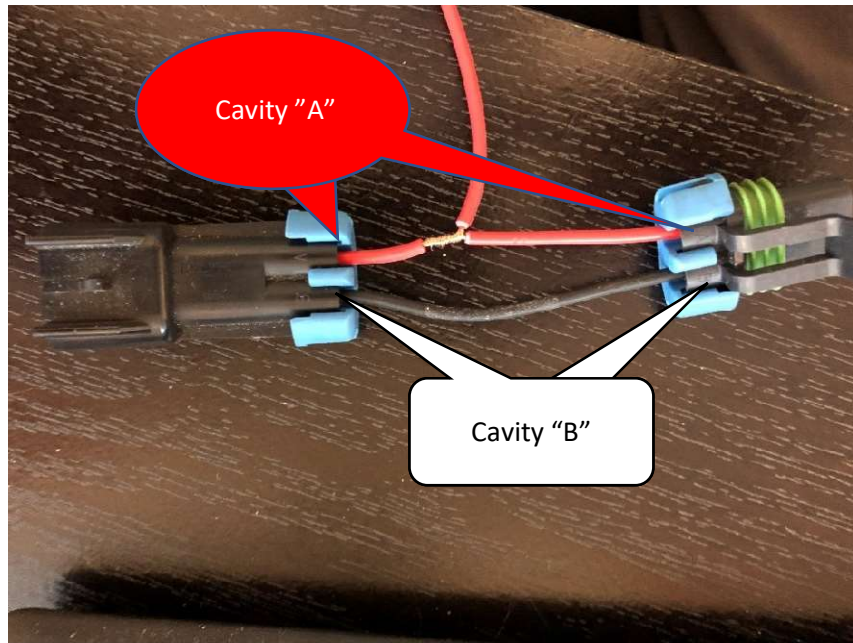

- Strip off approximately ½" of insulation and wrap around the center of the jumper wire and solder this connection and cover with Sealant type Heat Shrink Tubing.
- Install the seal and the Male and Female Terminals and crimp using the appropriate crimping tool
- Insert the terminals into the Connectors Cavity "A" Reference Figure 16 and Figure 17 Wiring Diagram

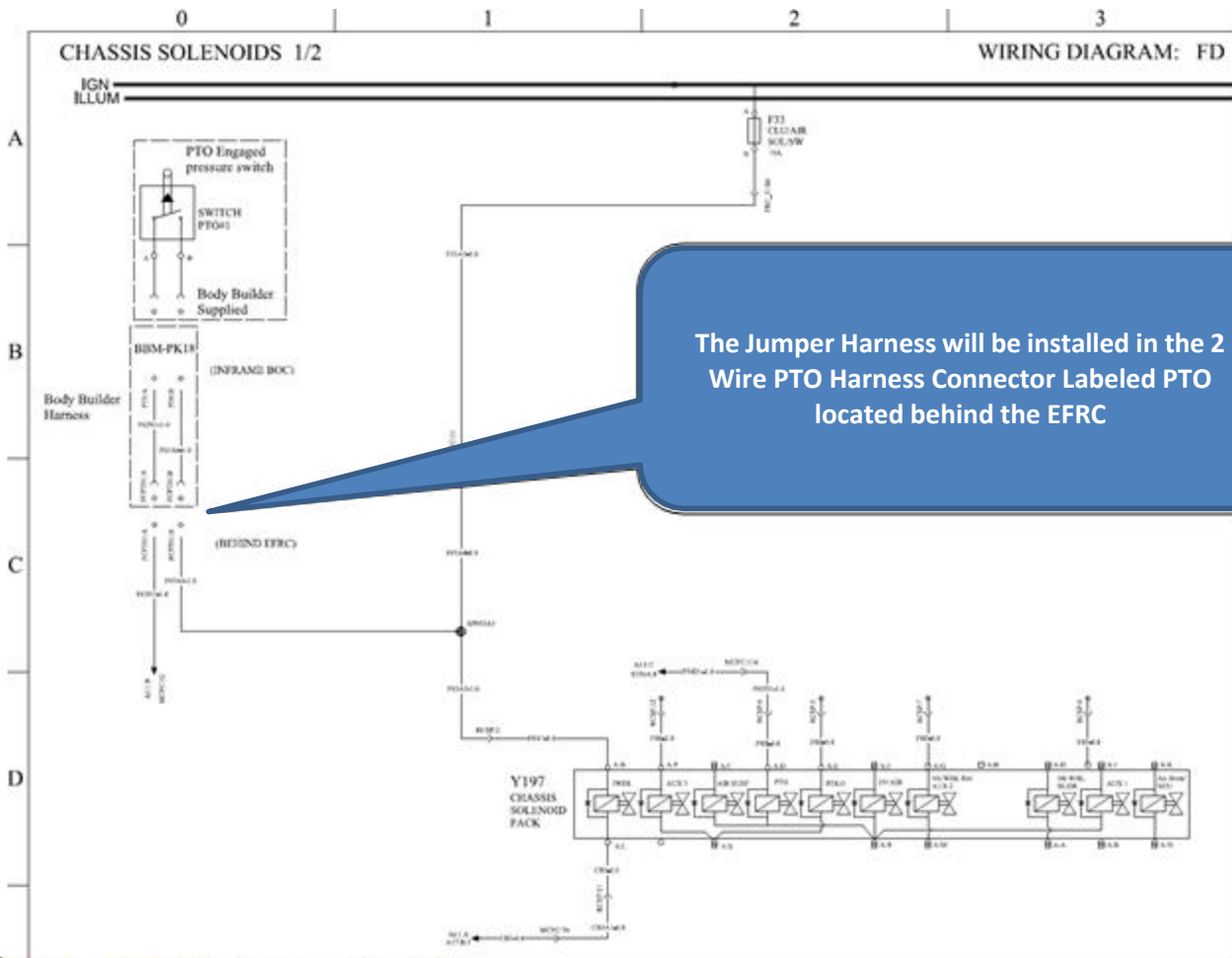

Figure 17

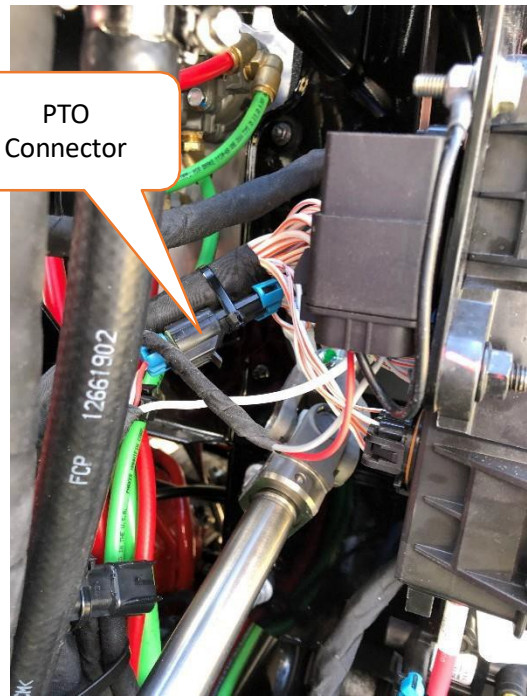

Figure 18 Cummins PTO Relay

Plug the 2-wire connector labeled PTO located near the PTO Opening on Transmission into the PTO Pressure Switch. Connectors may vary if needed remove the Connector on the Pressure Switch and replace with a mating Connector to the Mack Harness.

Under the hood locate the 2-wire PTO Connector, disconnect this connector, and plug the jumper harness into these connectors.

Take the free end of this wire and insert in the Sealed Relay Connector for Terminal 85.

Install terminal end for Sealed Relay Terminal 86 and insert, install a Ring Terminal on end of this wire and connect to the Mounting bolt used to mount the relay.

Take the free end of this wire and insert in the Sealed Relay Connector for Terminal 85.

Install terminal end for Sealed Relay Terminal 86 and insert, install a Ring Terminal on end of this wire and connect to the Mounting bolt used to mount the relay.



Figure 19 Cummins ECM J2 Connector

Take 2 lengths of 18ga wire to reach the Cummins ECM J2 Connector (Reference Figure 19. Disconnect the Batteries Negative first or turn off the Master battery Disconnect Switch is so equipped.

Remove the Cummins J2 Connector reference Figure 20.

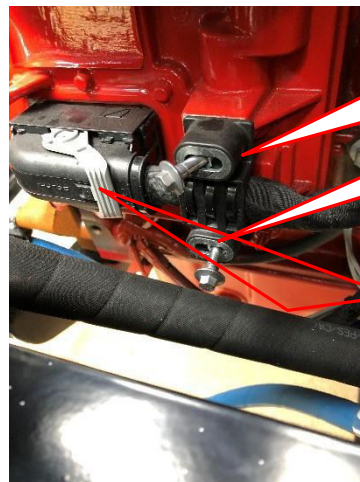

Figure 20

Remove these 2 bolts

Press down on the locking tab and pull up on the lever.

Note Do NOT close the lever after the connector has been removed from the ECM. Attempting to do so will cause damage.

If equipped, fold back the Dust Boot back to gain access to the ECM Connector. Remove the ECM Connector backshell by pressing in on the backshell locking tab and pivot the front of the backshell upwards, then pull the backshell forward, then upwards to release the backshell mounting tabs from the connector.

Gently release the Locking Comb by using retainer removal tool, Cummins part No. 4918919 to separate the locking comb from the connector body. Fully remove the locking comb by hand.

Locate Cavity 94 in the Cummins ECM J2 Connector, Reference Figure 21. Remove the seal plug from the J2 Connector.

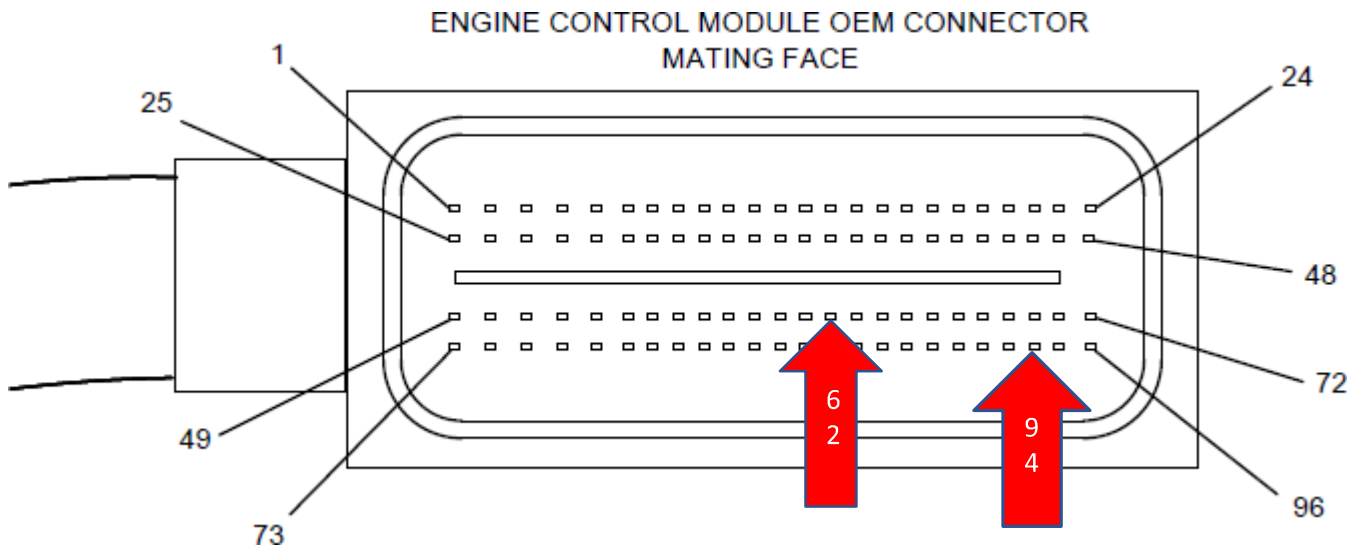

Figure 21 Cummins J2 OEM Connector

Take the Cummins Connector Pigtail Part No. 2892507 and insert the terminal into cavity 94. The wire terminals have a locating feature that only allow the terminal to be inserted in one orientation. Insert the wire from the top of the connector as the other wires. Push the wire into the connector until the terminal locks into place, pull on the wire gently to make sure the terminal is locked into the connector.

Locate and Remove the Terminal from Cavity 62 of the Cummins J2 Connector using Terminal Removal tool Cummins Part No. 4918921 into the larger access cavity. With the beveled side of the tool facing away from the terminal cavity slightly rotate the tool to release the terminal from the locking tang.

Carefully pull the wire from the connector. If it is difficult to remove, repeat this entire process.

Caution

If the wire is difficult to remove, DO NOT pull hard on the wire, otherwise, the locking tang of the terminal will stick, or the terminal will pull off the wire and remain in the connector body.

Insert the Terminal of Cummins Pigtail Part No. 2892507 into cavity 62 of the J2 Connector, verify the terminals are locked into the connector and carefully reinsert the Locking Comb. The Locking comb should slide into the connector without excessive force. If it is difficult to install the locking comb, check to verify all the terminals are fully lock into the connector.

Locate a good location to cut the terminal off the wire removed from cavity 62 strip approximately 1" of insulation off the wire and the wire to go to the PTO Relay.

Insert these 2 wires into the supplied Butt Connector on Pigtail 2892507 and crimp with Cummins Wire Crimping Tool Part No. 3163109. Using a Heat Gun Cummins Part No. 3822860 or equivalent heat the shrink tubing around the wire. Install the backshell onto the connector, **NOTE** Make sure the lever on the back shell is in the open position before

installing the backshell onto the connector. Position the wire bundle into place Position, install the backshell mounting tabs into the connector body and pivot the front of the backshell downward until the locking tab engages with the connector body. Install a wire tie to secure the wire bundle to the connector backshell. Reinstall the Hold down clamp to the Wiring harness bundle with wire ties (leave loose). Reinstall the J2 Connector into the ECM J2 Connector Opening and secure the lock lever. Reinstall the hold down bolts and torque to Cummins Specifications 71 in-lb. [8nm] then pull the wire ties tight and trim excess off.

On the free end of these wires from the J2 Connector Cavities 62 and 94 will be inserted into the Cummins PTO Relay terminals 30 and 87 reference figure 22.(See Below)

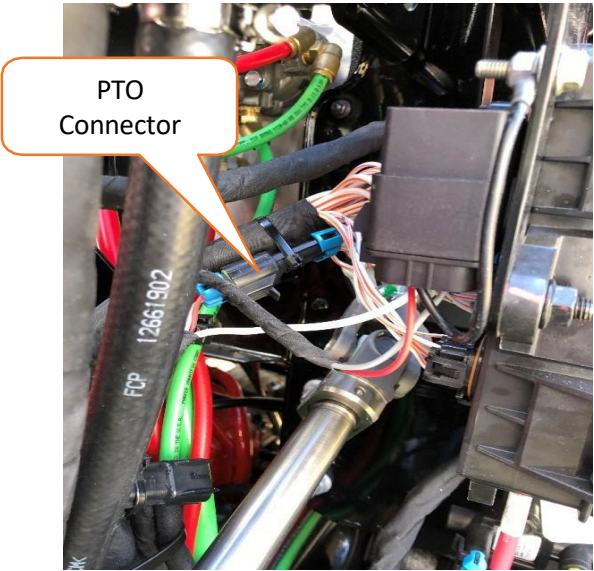

Using the Harness Tape, tape the wires from the Cummins PTO Relay to the Cummins ECM J2 Connector to the existing wiring harness.

If the Lock comb gets damaged a new part is available thru the Cummins Parts Department Part No. 4918926

After connecting the wires from the Cummins ECM J2 Connector to the PTO Relay. The Cummins ECM will require programming.





Using Cummins INSITE Software and Cummins Recommended Interface Adapter connect to the Green 9 Pin Diagnostic Connector located to the left of the Steering Column.

Here is how your PTO should be set up for Remote PTO. if while using the PTO, the vehicle will be stationary. Reference Figure 23

Features and Parameters	ECM Value	Units
<input checked="" type="checkbox"/> Parking Brake Switch	Enable	
<input checked="" type="checkbox"/> Powertrain Protection	Disable	
<input checked="" type="checkbox"/> PTO	Enable	
<input type="checkbox"/> Additional Switch Speed	950	RPM
<input type="checkbox"/> Maximum Engine Load	800	ft*lb
<input type="checkbox"/> Maximum Speed	2400	RPM
<input type="checkbox"/> Maximum Vehicle Speed	6	mph
<input type="checkbox"/> Minimum Speed	700	RPM
<input type="checkbox"/> Ramp Rate	250	rpm/s
<input type="checkbox"/> Resume Switch Speed	950	RPM
<input type="checkbox"/> Set Switch Speed	950	RPM
<input type="checkbox"/> PTO Speed 1 Device		
<input type="checkbox"/> PTO Speed 2 Device		
<input type="checkbox"/> PTO Speed 3 Device		
<input type="checkbox"/> PTO Speed 4 Device		
<input type="checkbox"/> PTO Speed 5 Device		
<input type="checkbox"/> PTO Speed 6 Device		
<input type="checkbox"/> PTO Speed 7 Device		
<input type="checkbox"/> PTO Speed 8 Device		
<input checked="" type="checkbox"/> Accelerator Pedal or Lever Override	Disable	
<input checked="" type="checkbox"/> Alternate Operation	Disable	
<input checked="" type="checkbox"/> Cab PTO	Enable	
<input checked="" type="checkbox"/> Clutch Override	Disable	
<input checked="" type="checkbox"/> Ignore Vehicle Speed Source in PTO	Disable	
<input checked="" type="checkbox"/> Parking Brake Interlock Type	None	
<input checked="" type="checkbox"/> PTO Pump Mode	Disable	
<input checked="" type="checkbox"/> Remote PTO	Enable	
<input checked="" type="checkbox"/> Number of Speeds	1	
<input type="checkbox"/> Set Speed 1	1000	RPM
<input checked="" type="checkbox"/> Remote PTO Service Brake and Clutch Override	Disable	
<input checked="" type="checkbox"/> Remote Station PTO	Disable	
<input checked="" type="checkbox"/> Service Brake Override	Enable	
<input checked="" type="checkbox"/> Transmission Driven PTO	Disable	
<input checked="" type="checkbox"/> Transmission Neutral Interlock	Disable	
<input checked="" type="checkbox"/> Zero Vehicle Speed Source Limit	Disable	

Figure 23

Note: Under SAE J1939 Multiplexing make sure PTO Options are disabled

	PTO On/Off Switch	Disable	
	PTO Resume Switch	Disable	
	PTO Set Switch	Disable	
	Remote Accelerator Position/Remote Accelerator Switch	Disable	
	Remote PTO Switch	Disable	

Set the Number of Engine Speeds and set each Set Speed as required. Using the Cummins Hardwired switch input make sure the circled item is set this way. After Programming the following will occur when PTO Switch is turned on.

The Engine Speed will jump to 1000 RPM and the PTO Icon in the Dash Cluster Tachometer Reference Figure 24.



Figure 24 PTO Icon Illuminated in Tachometer

Option 6. Allison 3000 Series PTO MD742 Chassis Built with Allison 3000 Series



With the Introduction of the Allison 3000 Series Transmission in the MD742 Chassis.

The Wiring for the Allison 3000 Series Transmission in the MD742 Chassis will only require 3 Wires wired into the Allison Body Builder Interface Connector

1. A switched 12Volt input from the PTO Switch to the Allison Body Builder Interface Connector Cavity 16 Wire ID N143A1-0.8. (PTO Request)
2. An output wire from the Allison Body Builder Interface Connector Cavity 11 Wire ID N130NO-0.8 to the PTO Solenoid on the PTO.
3. 12 Volt supply Input to Allison Body Builder Interface Connector Cavity 18 Wire ID N130CM-0.8 (can be split off wire from PTO Switch)
4. Wiring of the Cummins PTO Input also changes, with the installation of Cummins Body Builder Harness with Allison 3000 Series Service Harness Part No. 24186896. These can be wired through the Pressure Switch on the PTO Hydraulic Pressure Circuit.
 - a. Wire EC62A6-1.0 Cavity CUBB:D – BBCU:D
 - b. Wire EC94A1-1.0 Cavity CUBB:A – BBCU:A

Reference the Wiring Diagrams on the Mack Trucks Body Builder Portal, Wiring Diagrams, 6. Mack Medium Duty. Engine Control Cummins B Series US21 3/3 Body Builder Allison 3000 “Wiring Diagram CG”.

ENGINE CONTROL CUMMINS B SERIES US21 3/3 BODY BUILDER ALLISON 3000

WIRING DIAGRAM CG

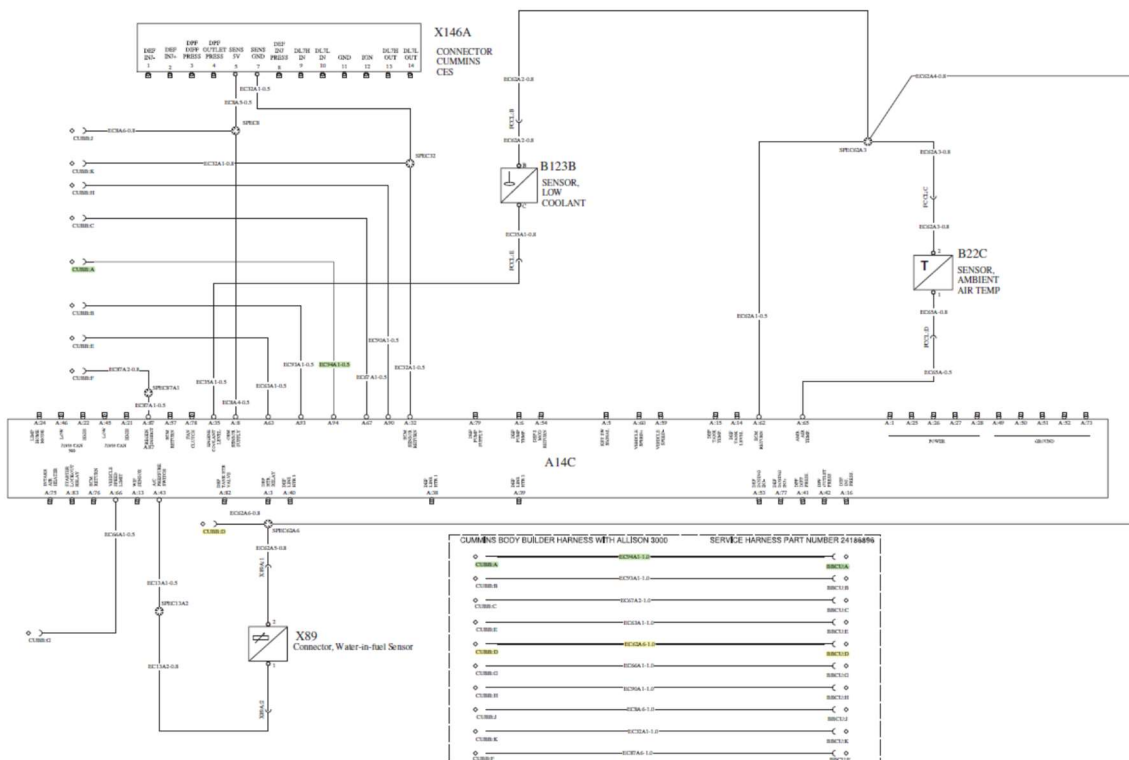

Cummins Accelerator Interlock

Note: For Certain Applications an Accelerator Interlock can be configured, proceed as follows.

Required Parts list

Qty	Description	Mack Part No.	Cummins Part No.
2	ECM Connector Pigtail		2892507
As Needed	18 AWG [0.8 MWG] Stranded Wire	Obtain Locally	
As Needed	Heat Shrink as needed	Obtain Locally	
1	Roll Harness Tape	20469544	

Disconnect the Batteries Negative first or turn off the Master battery Disconnect Switch is so equipped.



Figure 25 Cummins ECM J2 Connector

Take 2 lengths of 18ga wire to reach the Cummins ECM J2 Connector (Reference Figure 25).

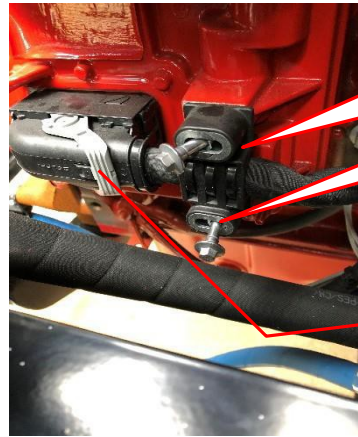

Remove these 2 bolts

Press down on the locking tab and pull up on the lever.

Note Do NOT close the lever after the connector has been removed from the ECM. Attempting to do so will cause damage.

Figure 26 Cummins J2 Connector

- If equipped, fold back the Dust Boot back to gain access to the Connector. Remove the ECM Connector backshell by pressing in on the backshell locking tab and pivot the front of the backshell upwards, then pull the backshell forward, then upwards to release the backshell mounting tabs from the connector. Reference Figure 26
- Gently release the Locking Comb by using retainer removal tool, Cummins part No. 4918919 to separate the locking comb from the connector body. Fully remove the locking comb by hand.
- Locate Cavity 93 in the Cummins ECM J2 Connector, Reference Figure 27. Remove the seal plug from the J2 Connector.

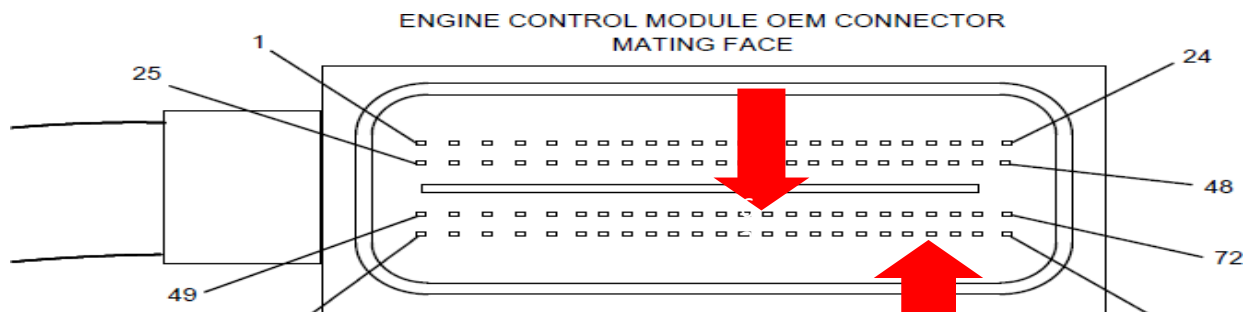

Figure 27 Cummins J2 OEM Connector

Take the Cummins Connector Pigtail Part No. 2892507 and insert the terminal into cavity 93. The wire terminals have a locating feature that only allow the terminal to be inserted in one orientation. Insert the wire from the top of the connector as the other wires. Push the wire into the connector until the terminal locks into place, pull on the wire gently to make sure the terminal is locked into the connector.

Locate and Remove the Terminal from Cavity 62 of the Cummins J2 Connector using Terminal Removal tool Cummins Part No. 4918921 into the larger access cavity. With the beveled side of the tool facing away from the terminal cavity slightly rotate the tool to release the terminal from the locking tang.

Carefully pull the wire from the connector. If it is difficult to remove, repeat this entire process.

Caution

If the wire is difficult to remove, DO NOT pull hard on the wire, otherwise, the locking tang of the terminal will stick, or the terminal will pull off the wire and remain in the connector body.

Insert the Terminal of Cummins Pigtail Part No. 2892507 into cavity 62 of the J2 Connector, verify the terminals are locked into the connector and carefully reinsert the Locking Comb. The Locking comb should slide into the connector without excessive force. If it is difficult to install the locking comb, check to verify all the terminals are fully lock into the connector.

Locate a good location to cut the terminal off the wire removed from cavity 62 strip approximately 1" of insulation off the wire and the wire to go to the PTO Relay.

Insert these 2 wires into the supplied Butt Connector on Pigtail 2892507 and crimp with Cummins Wire Crimping Tool Part No. 3163109. Using a Heat Gun Cummins Part No. 3822860 or equivalent heat the shrink tubing around the wire.

Install the backshell onto the connector, **NOTE** Make sure the lever on the back shell is in the open position before installing the backshell onto the connector. Position the wire bundle into place Position, install the backshell mounting tabs into the connector body and pivot the front of the backshell downward until the locking tab engages with the connector body. Install a wire tie to secure the wire bundle to the connector backshell. Reinstall the Hold down clamp to the Wiring harness bundle with wire ties (leave loose). Reinstall the J2 Connector into the ECM J2 Connector Opening and secure the lock lever. Reinstall the hold down bolts and torque to Cummins Specifications 71 in-lb. [8nm] then pull the wire ties tight and trim excess off.

Route these wires to a Proximity Switch or Body Company supplied Accelerator Interlock Switch

Cummins Programming

1. Using Cummins INSITE Software navigate to Features and Parameters
2. Locate Accelerator Interlock, if Disabled click on the ECM Value box and select Enable
3. Once the Accelerator is Enabled click on the "+" sign to the left of the Accelerator Interlock and set to Active as "Closed" click on "Send to ECM" follow on screen prompts.

CS6/8 SERIES



CLUTCH SHIFT POWER TAKE-OFF

DESIGNED FOR VERSATILITY

Designed to work on Allison 1000 and 2000 Series automatics and many other current manual transmissions, the CS6/8 Series power take-offs offer direct mount pump options and a drag brake. Upgrading to a multi-disk clutch brake allows for absolute shaft stoppage.



KEY FEATURES

- Transmission input gears: Fits most popular automatic and manual transmissions
- Three remote mount output shafts in keyed and flange types: Versatility for remote pump drives
- S.A.E. "A", "B", and "BB"; DIN 5462 direct mount pump options: Fits most popular pumps
- Rotatable direct mount flanges: Allows pump to be positioned for maximum clearance
- Muncie drag brake prevents shaft rotation in the "OFF" mode
- Optional pulse generator: System Protection Device monitors PTO shaft speed
- Available with integral solenoid for use with automatic transmissions

PTO TORQUE & HORSEPOWER RATINGS

SPEED RATIO	INTERMITTENT HP (KW) @ 1,000 RPM	INTERMITTENT TORQUE LBS.FT. (NM)	CONTINUOUS TORQUE LBS.FT. (NM)
03	57 (43)	300 (407)	210 (285)
04	57 (43)	300 (407)	210 (285)
05	57 (43)	300 (407)	210 (285)
06	57 (43)	300 (407)	210 (285)
07	57 (43)	300 (407)	210 (285)
09	52 (39)	275 (373)	193 (261)

Chelsea[®] 272/282 Series

PowerShift PTO - Air or Hydraulic
for Mechanical or Automatic Transmissions



Overview:

Power density is what you will find in the New Chelsea 272 Series PTO. This series is designed with a compact housing that helps eliminate clearance issues. High capacity bearings and superior gear designs support torque ratings up to 300 lbs-ft for ultimate performance. There is no need to de-rate the PTO for continuous duty applications. The robust design of this PTO transmits all the power you will need. It features eighteen shift options, twelve of which are integrated into the PTO housing. The hoses are included with the PTO for simplified ordering. Our popular Electronic Overspeed Control (EOG) is also available to protect your driven equipment. Nine internal gear ratios offer a wide variety of speeds to meet your application requirements. The direct mount pump flange options are available with our Wet Spline design that provides you with the confidence of increased PTO and pump shaft life.

NOTE: The 272 replaces the 230/231, 236 and 270/271. The 282 replaces the 238.

- LP Gas Trucks
- Water Trucks
- Tow and Recovery
- Service Trucks
- Dump Trucks
- Aerial Trucks

Contact Information:

Parker Hannifin Corporation
Chelsea Products Division
8225 Hacks Cross Road
Olive Branch, MS 38654 USA

Phone: 1-888-PH4-TRUK
(1-888-744-8785)

Fax: 1-662-895-1069
chelseacustserv@parker.com
www.parker.com/chelsea



Product Features and Benefits:

- SAE 6-Bolt housing - 272
- Low profile SAE 6-Bolt housing - 272M
- SAE 8-Bolt housing - 282
- Air or Hydraulic Shift Options
- Integrated Air Valve - No remote valve (patent pending)
- Shaft Brake - Internal self-adjusting (patent 7159701)
- Wet Spline Option - Extends PTO and pump shaft life
- Pressure lubrication - Extends PTO service life
- Electronic Overspeed Control - Protects driven equipment
- Single Duty Torque Rating - Continuous duty
- Smart Start Option - Reduces high inertia startup

5298734 CM2350 ECM CONNECTOR REPAIR KIT

Bulletin 3400445

4918925
Delphi™
96 Position
Qty 3



4918926
Delphi™
96 Position, Comb Lock Retainer
Qty 3



5298539
Delphi™
ECM Harness Clamp
Qty 2



3822924
Panduit™
7.4 Inch Long
Qty 12



2892507
Delphi™
Size 1.2, Micro, Socket, 0.5 MM2 (20 AWG)
Qty 12



4918916
Delphi Packard™
Size 1.2, Micro, Socket, 1.0 MM2 (16 AWG)
Qty 6



Call 800-DIESELS (343-7357)

Cummins Inc. • Box 3005 • Columbus, Indiana 47202-3005 USA

Delphi 96 Way Cummins ECM Connector

Select Service Tools

Recommended Cummins® Service Tools

- Engine control module (ECM) connector electrical circuit tester, Part Number 2892510
- Test lead, Part Number 3164113
- ECM Connector Repair Kit, Part Number 2892512
- Retainer removal tool, Part Number 4918919
- Terminal removal tool, Part Number 4918921
- Wiring stripping tool, Part Number 3400045, or equivalent
- CM2350 Wiring Harness Repair Kit, Part Number 5298734
- Wire crimping tool, Part Number 3163109, or equivalent
- Heat gun, Part Number 3822860, or equivalent

Additional Service Items

- Wire cutters

General Information

This connector is used to attach the engine wiring harness and the original equipment manufacturer (OEM) harness to the ECM.

Note: The engine harness connector and the OEM connector are keyed differently, so they cannot be used interchangeably.

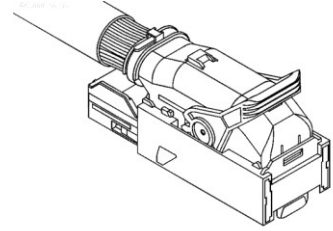

19b00076

The Delphi® 96 Way ECM connector is made up of three components:

1. Backshell
2. Connector body
3. Locking comb.

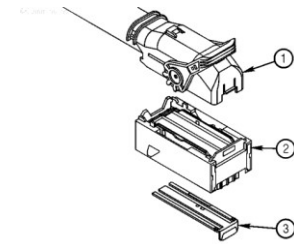

19b00077

⚠ WARNING ⚠

Batteries can emit explosive gases. To reduce the possibility of personal injury, always ventilate the compartment before servicing the batteries. To reduce the possibility of arcing, remove the negative (-) battery cable first and attach the negative (-) battery cable last.

- Disconnect the batteries. See equipment manufacturer service information.

Preparatory Steps

Remove

Unbolt the wire harness hold down clamp from the ECM.

Note: Do **not** remove wire ties securing the hold down clamp to the wire harness.

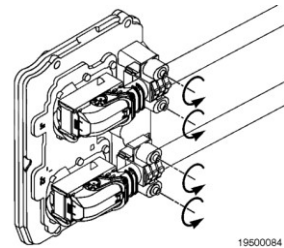

If equipped, fold the dust boot back to gain access to the ECM connector or remove it if necessary.

Note: If the dust boot is removed, it **must** be installed at the conclusion of the repair.

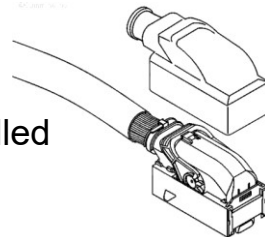

⚠ CAUTION ⚠

Damage to the backshell will occur if the locking tab is not depressed prior to lifting of the lever

Remove the connector from the ECM by pressing down

Note: Do **not** close the lever after the connector has been removed from the ECM. Attempting to do so will cause

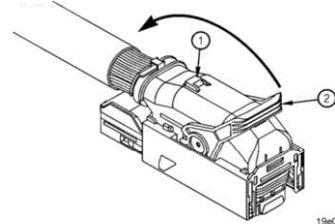

Test

CAUTION ⚠

Do not insert test leads into the ECM connector terminals. Doing so may cause terminals to spread and cause intermittent electrical connections

To perform pin-out diagnostic checks, use ECM connector electrical circuit tester, Part Number 2892510, and test lead, Part Number 3164113.

All diagnostic test leads, connector repair tools, and repair terminals can be found in CM2350 ECM Connector Repair Kit, Part Number 2892512.

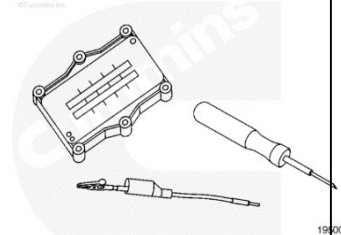

Attach the electrical circuit tester, Part Number 2892510, to the ECM (1) connector by placing the electrical circuit tester into the ECM connector and pulling back on the locking lever (2) until the connector is fully seated and the lever locking tab (3) is engaged.

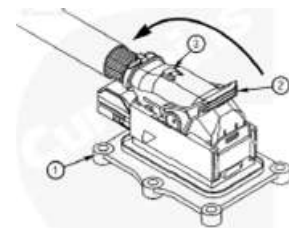

Use electrical circuit tester, Part Number 2892510, to help identify terminal number locations.

See the appropriate wiring diagram for circuit terminal locations.

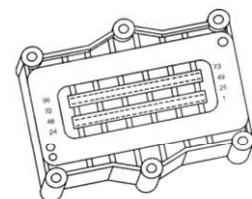

Pin Replacement

Cut the wire tie securing the wire bundle to the backshell.

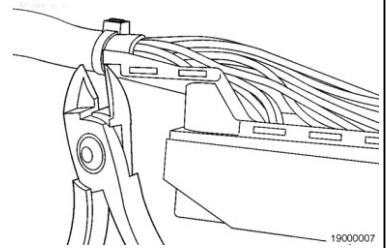

Remove the connector backshell by pressing in on the backshell locking tab (1). Pivot the front of the backshell upward (2).

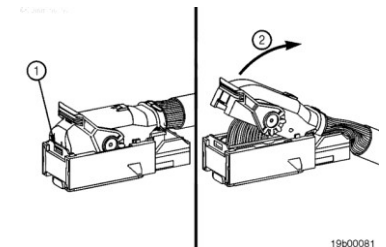

Pull the backshell forward, then upward to release the backshell mounting tabs from the connector body.

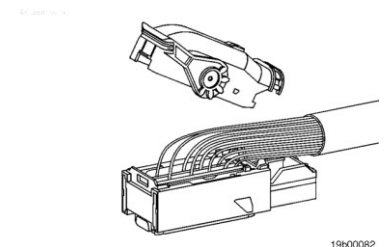

Gently release the locking comb by using retainer removal tool, Part Number 4918919, to separate the locking comb from the connector body. Fully remove the locking comb by hand.

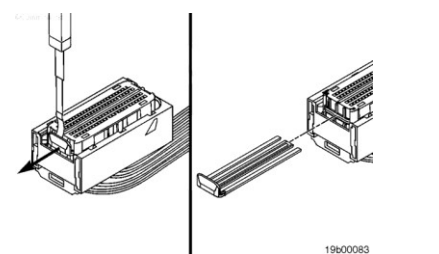

Removing Terminal

Replace one terminal wire at a time. If more than one terminal wire **must** be replaced, attach an identification tag to each wire removed.

If more than four terminals are damaged and need to be replaced, the engine wiring harness is to be replaced.

See the appropriate wiring diagram for terminal locations.

See the appropriate wiring harness repair kit in the Service Tools procedure in Section 19 for the correct repair wire.

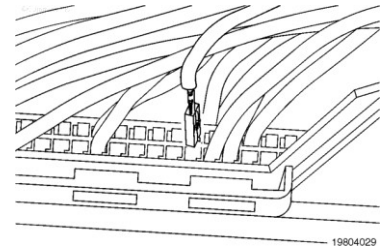

⚠ CAUTION ⚠

If the wire is difficult to remove, do not pull hard on the wire, otherwise, the locking tang of the terminal will stick or the terminal will pull off the wire and remain in the connector.

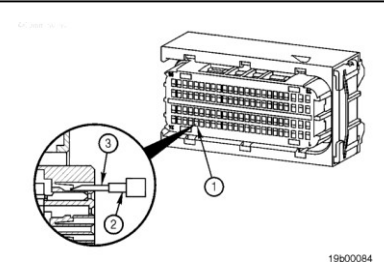

Insert terminal removal tool, Part Number 4918921, into the larger access cavity (1).

With the beveled side of the tool facing away from the terminal cavity (2), rotate the tool slightly to release the terminal from the locking tang (3).

Carefully pull the wire from the connector. If it is difficult to remove, repeat the entire process

Use wire cutters to remove 25 mm [1 in] of the terminal and wire to be replaced.

Use wire stripping tool, Part Number 3400045, or equivalent, to remove 6 mm [0.25 in] of insulation from the wire.

Note: It will be necessary to remove the wire ties securing the wire harness hold down clamps to the wire harness. Wire ties **must** be replaced at the conclusion of the repair.

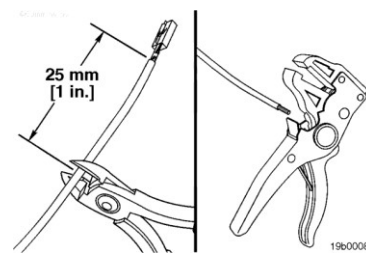

There are two electrical connector repair terminals available for the ECM connector.

Part Number 4918916, identified by a grey wire with a red stripe, is used to repair 16-gauge wires used in cavities 1-4, 25-28, 49-52, and 73-76 (1).

Part Number 2892507 is used to repair 20-gauge wires used in cavities 5-24, 29-48, 53-72, and 77-96 (2).

See CM2350 Wiring Harness Repair Kit, Part Number 5298734, for the appropriate repair terminal.

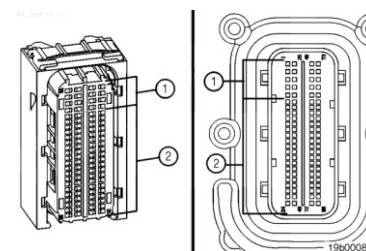

In some applications, there may **not** be enough clearance to route the repair terminal butt-splice connection into the wire harness convolute. The repair terminal will need to be cut to appropriate length to allow the butt-splice connection to be located under the backshell.

Note: The repair wire is 203 mm [8 in] long.

Use a wire cutter to cut the electrical connector repair terminal to an appropriate length so it can be attached to the original wire lead, using a butt-splice, under the connector backshell.

Note: If more than four terminals are damaged and need to be replaced, the wiring harness is to be replaced.

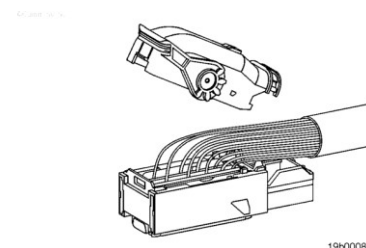

Before installing the new repair wire, perform a test fit to make sure the wire is the correct size.

Install the repair wire on the bare wire.

Make sure the bare wire extends into the splice connector properly.

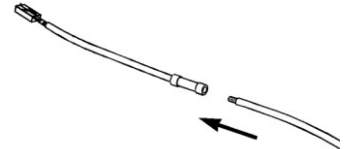

19d01802

Use wire crimping tool, Part Number 3163109, or equivalent, to crimp the repair wire onto the bare wire.

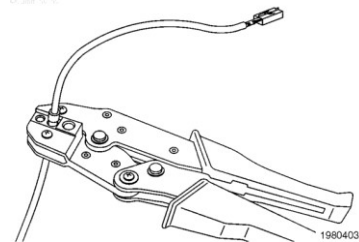

19804032

Use heat gun, Part Number 3822860, or equivalent, to heat the shrink tubing around the wire.

The tubing will shrink and make the connection waterproof.

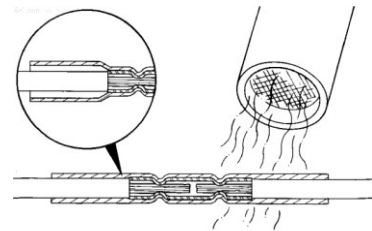

22900119

Inserting Terminal

The wire terminals have locating features that only allow the terminal to be inserted in one orientation.

Insert the wire from the top of the connector.

Push the wire into the connector until the terminal locks into place.

Pull on the wire gently to make sure the terminal is locked into the connector.

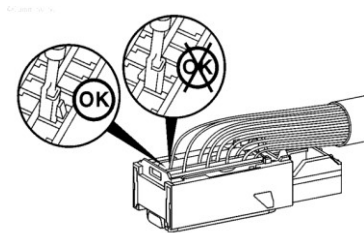

19b00087

Install

Insert the locking comb.

Note: The locking comb should slide into place without excessive force. If it is difficult to install the locking comb, check to ensure all pins are fully engaged.

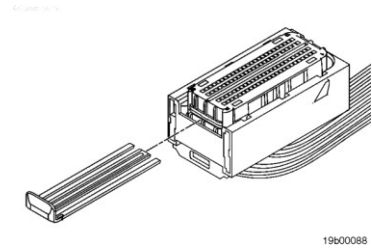

Note: Make sure the lever on the backshell is in the open position before installing the backshell onto the connector body.

Position the wire bundle into place. Install the backshell mounting tabs into the connector body.

Pivot the front of the backshell downward until the locking tab engages with the connector body.

Install a wire tie to secure the wire bundle to the connector backshell.

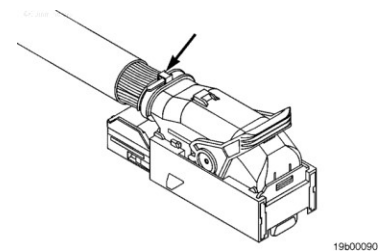
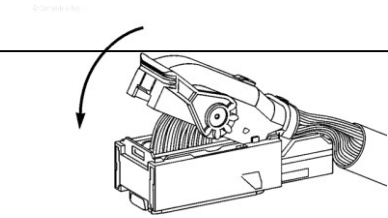

If the harness hold down clamps were removed from the harness, loosely attach the hold down clamps to the wire harness using wire ties.

Once the connector has been attached to the ECM and the hold down clamp has been attached to the ECM, the wire ties can be pulled tight, securing the hold down clamp to the wire harness.

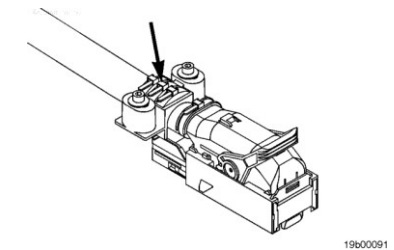

Install the connector to the ECM by placing the connector into the ECM receptacle and pulling back on the locking lever until the connector is fully seated and the lever locking tab is engaged.

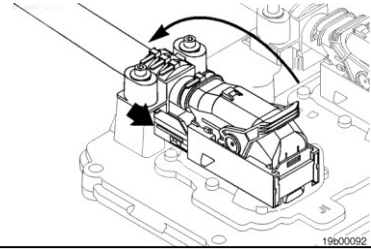

If equipped, fold the dust boot back into place over the ECM connector.

If the dust boot was removed, install it over the ECM connector. Secure it to the harness using a wire tie.

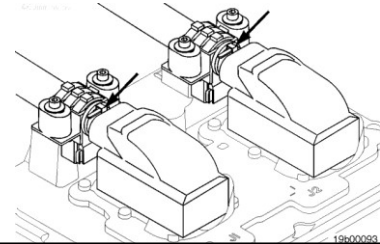

⚠ CAUTION ⚠

Do not over-tighten the harness hold-down clamp mounting screws or damage to the ECM will occur.

Install the harness hold-down clamps.

Torque Value: 8 n•m [71 in-lb]

Note: If the wire ties securing the harness hold-down clamp to the wire harness were removed, new wire ties **must** be installed.

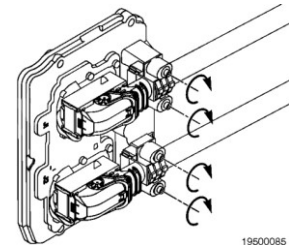

Finishing Steps

Warning

Batteries can emit explosive gases. To reduce the possibility of personal injury, always ventilate the compartment before servicing the batteries. To reduce the possibility of arcing, remove the negative (-) battery cable first and attach the negative (-) battery cable last.

- Connect the batteries. See equipment manufacturer service information.
- Operate the engine. Check for loose components and fault codes.

Optional Cummins PTO Engine Speed Controls and Programming

Remote Switch PTO Engine Speed Control

1. PTO Engine Speed Control with Remote Switch. Wiring
 - a. Using appropriate Weatherproof switches wire a Single Throw switch to the Cummins J2 OEM ECM Connector cavities 90 (PTO Enable) and 62 (ECM Return).
 - b. Wire in a Momentary Double Throw switch to the Cummins J2 OEM ECM Connector cavities 12 (PTO Set), 19 (PTO Resume) and 62(ECM Return).
2. To raise engine speed from idle ground (Pin 62) and hold Pin 19 (PTO Resume). If the ground is in place engine speed will ramp up until it reaches Set RPM. Remove the ground while speed is ramping up the engine speed will hold at wherever it is at. To decrease engine speed, Ground (Pin 62) and hold Pin 12 (PTO Set).
3. Now if this operates backwards, for example Pin 19 lowers speed and Pin 12 raises speed then change the setting of this feature.
 - a. Using INSITE Software change the setting.

Cruise Control Switch Setup		
Switch Setup		Set/Coast (Resume/Accelerate)

4. Program the PTO Settings using Cummins INSITE Software as outlined below. (Set Engine Speeds as required)

PTO	Enable
Additional Switch Speed	950 RPM
Maximum Engine Load	800 ft*lb
Maximum Speed	1200 RPM
Maximum Vehicle Speed	6 mph
Minimum Speed	750 RPM
Ramp Rate	200 rpm/s
Resume Switch Speed	750 RPM
Set Switch Speed	750 RPM
PTO Speed 1 Device	
PTO Speed 2 Device	
PTO Speed 3 Device	
PTO Speed 4 Device	
PTO Speed 5 Device	
PTO Speed 6 Device	
PTO Speed 7 Device	
PTO Speed 8 Device	
Accelerator Pedal or Lever Override	Disable
Alternate Operation	Enable
Cab PTO	Enable
Clutch Override	Disable
Ignore Vehicle Speed Source in PTO	Disable
Parking Brake Interlock Type	None
PTO Pump Mode	Disable
PTO Speed Adjustment	Disable
Remote PTO	Disable
Remote PTO Service Brake and Clutch Override	Disable
Remote Station PTO	Disable
Service Brake Override	Disable
Transmission Driven PTO	Disable
Transmission Neutral Interlock	Disable
Zero Vehicle Speed Source Limit	Disable

Alternate Operations such as SplitShaft PTO

1. PTO Pump Mode Wire into the ECM. Used with Split Shaft PTO Operations
 - a. Using appropriate Weatherproof switch wire a Single Throw switch to the Cummins J2 OEM ECM Connector cavities 66 (PTO Pump Mode) and 62 (ECM Return).

The attached screen shot is how to set it up but there are some options depending on what you are trying to do. The highlighted parameters are important. You can ignore the others.

PTO -> Maximum Speed will limit the engine speed while the PTO governor is active. However, this engine is governed at 2100 RPM so it will not go above 2100 RPM.

PTO -> Maximum Vehicle Speed set to 25 just gets it out of the way.

Now, let's assume, start at idle and ramp up from there

PTO -> Minimum Speed = 750 RPM

PTO -> Ramp Rate – They can set that to whatever they want. A high number will not be achievable, such as 1500 RPM/s due to mechanical and performance limits of the engine.

PTO -> Resume Switch and Set Switch – Set both to 750 RPM which matches idle speed.

PTO -> Accelerator Pedal or Lever Override – Set to Enable if they want the cab throttle to work while the Cummins PTO governor is active. If they want a dead throttle pedal, then set to Disable

PTO -> Alternate Operation – This is the feature that allows the engine speed to start at idle and then you ramp up until you reach Maximum Speed. You can also ramp down and vary engine speed as needed.

PTO -> Cab PTO – Must be set to Enable

PTO -> Ignore Vehicle Speed Source in PTO – Must be Disable



































PTO -> Parking Brake Interlock Type – Must be set to None otherwise PTO will be looking to see the Parking Brake set.

PTO -> Service Brake Override – If they want the PTO governor to cancel when the Service Brake is depressed then set to Enable, if they want to ignore the Service Brake then set to Disable

PTO -> Transmission Driven PTO – Set to Enable (This feature will be used to disable the speedometer when in work mode)

PTO -> Transmission Driven PTO -> Transmission Driven PTO Type – Set to Transmission Driven – Irregular Load

PTO -> Transmission Driven PTO -> Vehicle Speed Sensor Operation – Setting to Disable turns off the speedometer and odometer.

 PTO		Enable
 Additional Switch Speed		950 RPM
 Maximum Engine Load		800 ft*lb
 Maximum Speed		2400 RPM
 Maximum Vehicle Speed		25 mph
 Minimum Speed		750 RPM
 Ramp Rate		250 rpm/s
 Resume Switch Speed		750 RPM
 Set Switch Speed		750 RPM
 PTO Speed 1 Device		
 PTO Speed 2 Device		
 PTO Speed 3 Device		
 PTO Speed 4 Device		
 PTO Speed 5 Device		
 PTO Speed 6 Device		
 PTO Speed 7 Device		
 PTO Speed 8 Device		
 Accelerator Pedal or Lever Override		Enable
 Maximum Engine Speed		2400 RPM
 Alternate Operation		Enable
 Cab PTO		Enable
 Clutch Override		Disable
 Ignore Vehicle Speed Source in PTO		Disable
 Parking Brake Interlock Type		None
 PTO Pump Mode		Disable
 PTO Speed Adjustment		Disable
 Remote PTO		Disable
 Remote PTO Service Brake and Clutch Override		Disable
 Remote Station PTO		Disable
 Service Brake Override		Disable
 Transmission Driven PTO		Enable
 Transmission Driven PTO Type		Transmission Driven - Irregular...
 Vehicle Speed Sensor Operation		Disable
 Transmission Neutral Interlock		Disable
 Zero Vehicle Speed Source Limit		Disable

Mack Medium Duty Body Builder Manuals: <https://www.macktrucks.com/parts-and-services/support/body-builders/manuals/medium-duty>

Mack Medium Duty Wiring Diagram: https://www.macktrucks.com/-/media/files/body-builder/wiring-diagrams/mack-md_23939215-03-1-w.pdf

Updates:

12/28/2021

Under Option 4. PTO Dash Switch to Control Allison PTO Engagement

Page 10:

Step 2. Corrected mis-type Cavity "M" to Cavity "W"

Step 5. Corrected mis-type Cavity for Terminal 84 to Cavity for Terminal 87

Under Cummins Accelerator Interlock

Page 13:

Cavity 88 should read Cavity 93

Updated figure 21 to reflect the correct Pin 93 Location

02/17/2022

Optional Cummins PTO Engine Speed Controls and Programming

07/13/2022

Rewrite instructions to make Instructions clearer

Addition of Parker PTO Information.

01/06/2023

Added the New Brown Allison BB Connector Wire ID in Cavity location, Cleaned up spelling errors. Realigned Jumper Harness Callouts to Connectors page 15.

3/13/2023

Option 6. Allison 3000 Series PTO MD742 Chassis