

# BODY BUILDER INSTRUCTIONS

Mack Trucks



Cab, Instrument Panel  
PI / CHU, AN / CXU, GR / GU, TD  
LR, TE / MRU  
Section 8

## Introduction

This information provides specifications for chassis body installation for MACK vehicles.

**Note:** We have attempted to cover as much information as possible. However, this information does not cover all the unique variations that a vehicle chassis may present. Note that illustrations are typical but may not reflect all the variations of assembly.

All data provided is based on information that was current at time of release. However, **this information is subject to change without notice.**

Please note that no part of this information may be reproduced, stored, or transmitted by any means without the express written permission of MACK Trucks, Inc.

## Contents:

- "AN, GR, PI DASHBOARD SWITCH LOCATIONS", page 3
- "Overview of Instruments", page 7
- "Gear selector for Allison transmission", page 8
- "Instrument Cluster", page 9
- "Gauge Layout", page 10
- "Alarm, Check and Information Symbols", page 16
- "Warning Indicator Light Panel", page 18
- "Dash Switches", page 20
- "Switch Package AUXSW-6B Assignable Body Builder Dash Mounted Rocker Switches", page 21
- "Lens Kit for Assignable Body Builder Switches: Part # 22392309", page 22
- "TE/MRU Dash Panel", page 23
- "Gauge Layout", page 24
- "Right Hand Gauges", page 25
- "Alarm, Check and Information Symbols", page 27

- “Warning Indicator Light Panel”, page 29
- “LR DASH PANEL”, page 32
- “Alarm, Check and Information Symbols”, page 34
- “Warning Indicator Light Panel”, page 35
- “PTO”, page 37
- “VECU/BBM Locations”, page 41

# Instrument Panel

## AN, GR, PI DASHBOARD SWITCH LOCATIONS

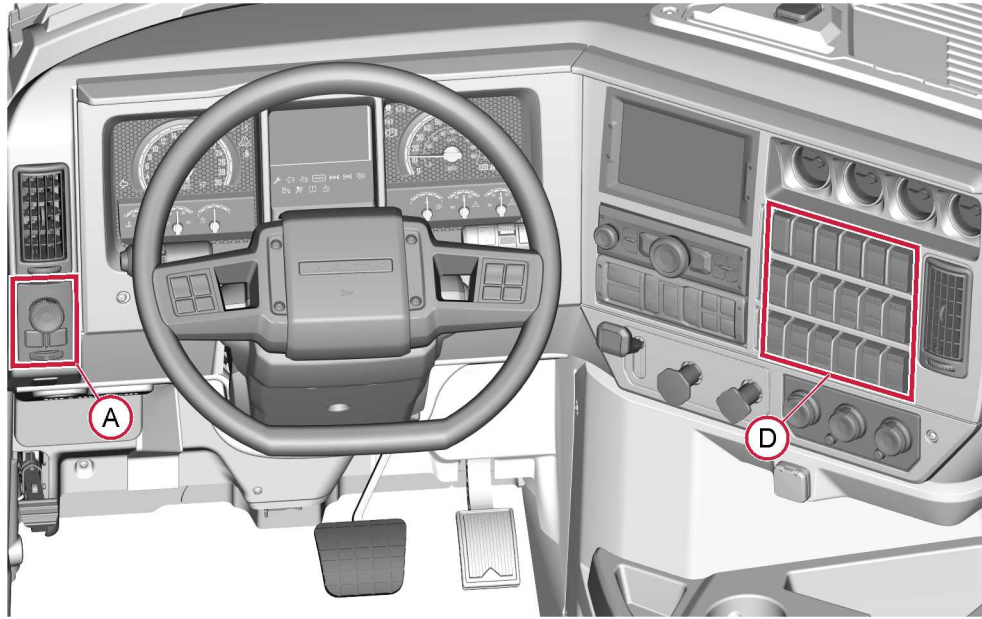

T8204023

**Panel Arrangement A and D**

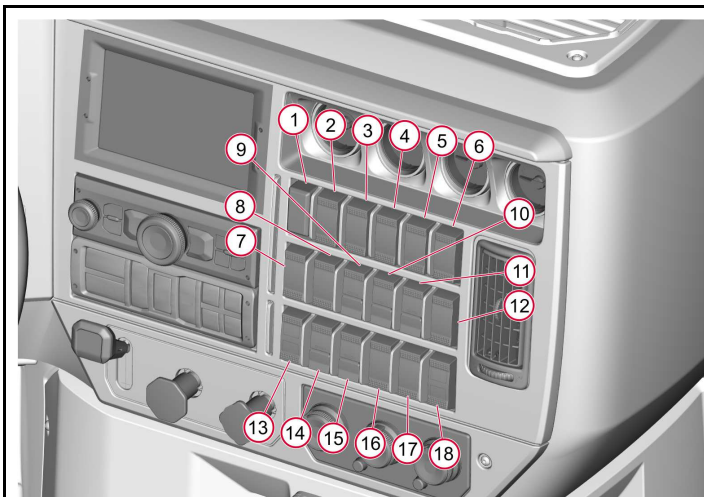

W3133550

Panel D

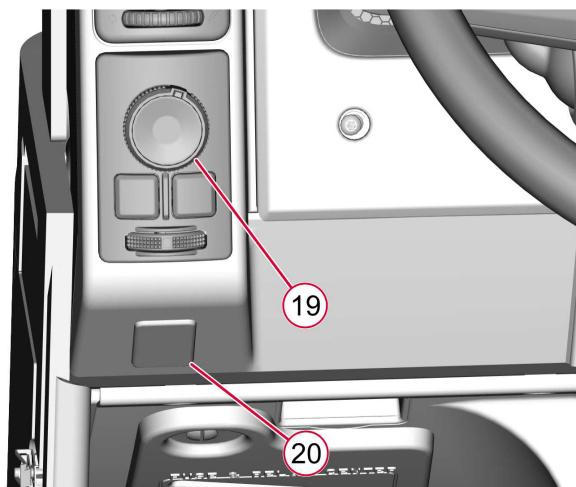

W3133551

Panel A

Number	Part Number	Description
1	22392299	Cruise ON / OFF
2	22392282	Cruise SET / RESUME
3	22559210	Cummins Engine Brake
4	22392546	Grade Gripper Disable
5	22392314	ATC (MUD / SNOW)
6	22393029	Trailer AUX (CENTER PIN)
7	22396611	IGN AUX
8	22392442	DIFF LOCK (INTER WHEEL)
9	22846096	INTERAXLE LOCK
10	22392259	PLOW LAMPS
11	22559918	AIR SUSP (DUMP)
12	22392281	STROBE
13	22392399	BATTERY AUX
14	22846105	PTO 1
15	22846105	PTO 2
16	22559226	BEACON LIGHT
17	23229511	FAN CLUTCH OVERRIDE
18	22392285	ASSIGNABLE ON / OFF

19	23006490	HEADLAMP SWITCH
20	82719617	FLOOR LAMP SWITCH (non-gas only)

**OTHER AVAILABLE SWITCH OPTIONS**

<b>Part Number</b>	<b>Description</b>
22572307	LDWS DISABLE
22392308	TIME GAP (ACC)
22392420	ATC
22392256	RETARDER
22392260	ASSIGNABLE ON / OFF
22392286	WINDSHIELD DEFROST
22392297	ECS RAISE / LOWER
22392311	ASSIGNABLE MOMENTARY
22396071	POWER FLOAT
22396079	LOW HYDRA OIL OVERRIDE
22396090	SPREADER LIGHTS
22396625	REAR AMBER FLASHER
22559241	SANDER LIGHT
22559244	CHAIN LIGHT
22559245	ROTATING LIGHT
22559917	BOGIE CONTROL
22846089	TAIL GATE LOCK / UNLOCK
22846090	TAIL GATE LOCK / UNLOCK
22846091	SNOW INGESTION
22846093	NEUTRAL CONTROL
22846096	INTERAXLE
22846097	SUSP HEIGHT CONTROL
22846101	5TH WHEEL
22846108	PTO CONTROL (MUNCIE)
22846121	ECS MODE
22879194	LOAD LIGHT
23053219	FORWARD LIFT AXLE
23053220	REAR LIFT AXLE
23093324	FRONT DIFF LOCK
23093325	REAR DIFF LOCK
23229509	SHUTDOWN OVERRIDE
23229510	WINDSHIELD DEFROST
23229512	ATC
23229513	INTER WHEEL LOCK
23229514	GRADE GRIPPER DISABLE
23229515	LOW HYDRA OIL OVERRIDE
23229516	LDWS DISABLE
23229517	FRONT DIFF LOCK

Part Number	Description
23229518	REAR DIFF LOCK
23239140	ASSIGNABLE MOMENTARY
23239141	IGNITION (15 AMP)
23239142	REAR AMBER FLASHER

*Notes*

---



---



---



---



---



---



---



---

# Overview of Instruments

Before driving this vehicle, locate the instruments and controls, and become thoroughly familiar with their operation. After starting and when driving, ensure that the instrument readings are normal.

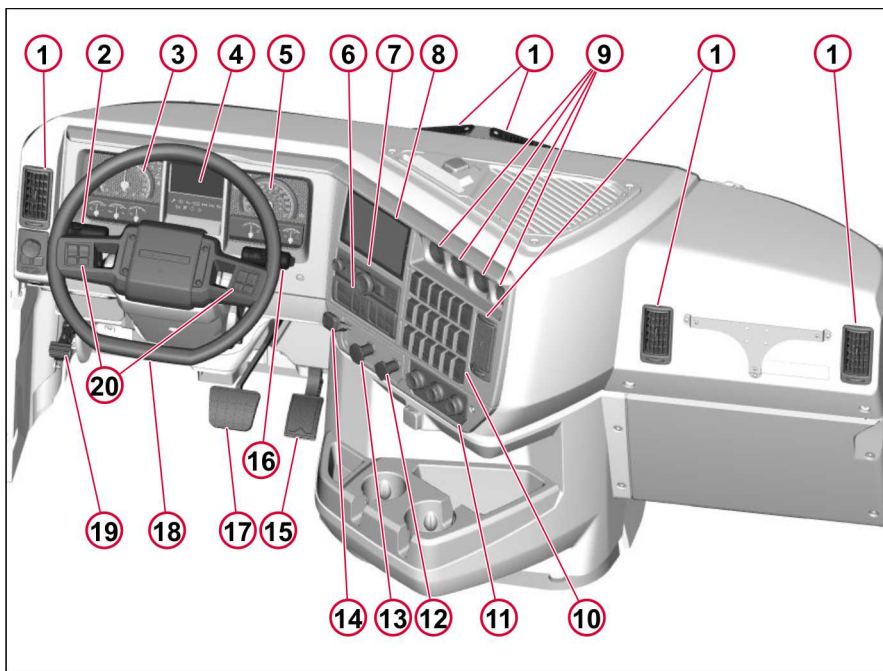

W8133358

1. Air Vent	8. Infotainment Screen / Display (SID)	15. Accelerator Pedal
2. Stalk Control	9. Secondary Gauges	16. Stalk Control
3. Tachometer	10. Dash Switches	17. Brake Pedal
4. Drivers Information Display (DID)	11. Climate Control Unit	18. Steering Wheel
5. Speedometer	12. Trailer Air Supply	19. Steering Column Tilt Control Pedal
6. mDRIVE//Allison Transmisison Gear Selector	13. Tractor Parking Brake	20. Steering Wheel Switches
7. Radio (SEM)	14. Trailer Hand Brake	

# Gear selector for Allison transmission

Trucks variants equipped with Allison automatic transmission feature a gear selector, as shown in the illustration.

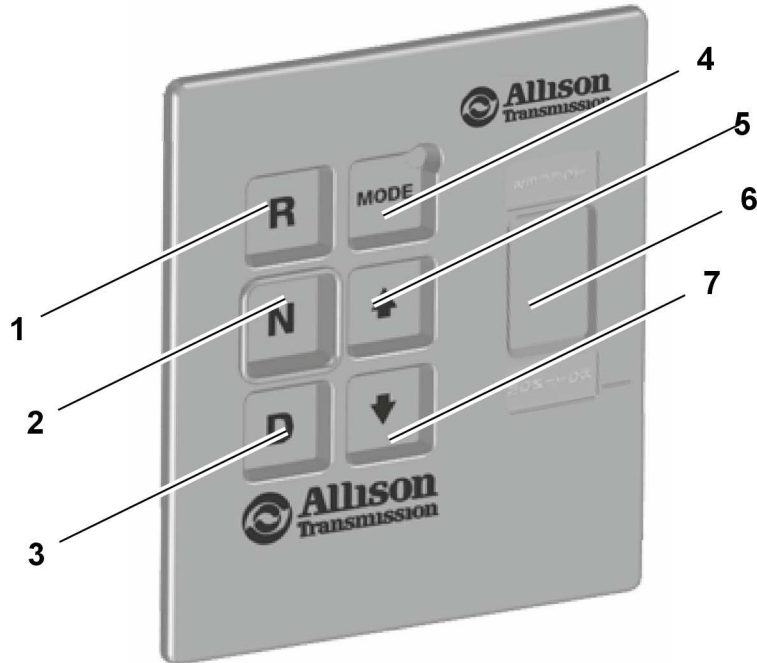

T4202677

1. Reverse Button	5. Upshift Button
2. Neutral Button	6. Select/Monitor Display
3. Drive Button	7. Downshift Button
4. Mode Button	

**Note:** For additional instructions on operating the gear selector, please refer the driver manual.



# Instrument Cluster

The instrument cluster provides system/component condition information to the driver. This information is available to assist the driver in determining any necessary actions.

The instrument cluster consists of the following components: condition indicators (tell-tales), driver information display (DID), gauges, speedometer and tachometer, on board diagnostic (OBD) fault and warning indicators.

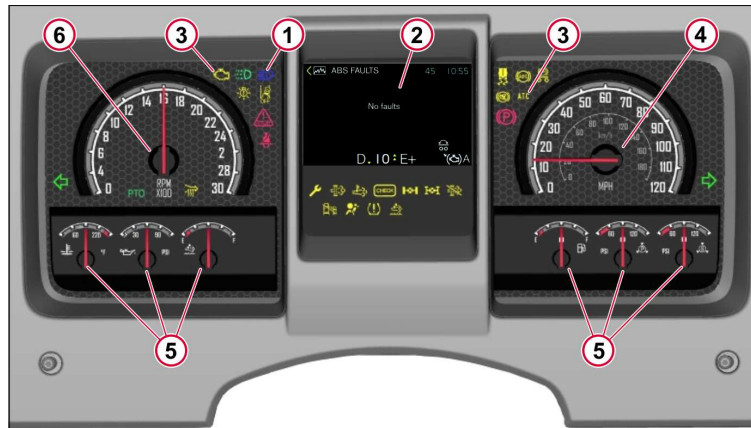

W8133359

1. Condition Indicators (Tell-tale)
2. Driver Information Display (DID)
3. On Board Diagnostic (OBD) Fault and Warning Indicators
4. Speedometer
5. Gauges
6. Tachometer

## Notes

---

---

---

---

---

---

# Gauge Layout

## Tachometer

The tachometer displays the engine's revolutions per minute (RPMs).



W3133360

## Speedometer

Indicates the speed of the vehicle. The speedometer is driven by the vehicle's electronic system.



W3133361

## Coolant Temperature Gauge

The coolant temperature gauge indicates engine coolant temperature. The normal operating temperature for Mack engines is 80 to 105° C (170–215° F). If the temperature remains below or exceeds the normal temperature range, the cooling system should be checked for problems by an authorized Mack Vehicle dealer. When coolant temperature is excessive, the red STOP tell-tale illuminates and the buzzer will sound. The engine is at risk and the ECM may derate the engine power. Stop at the first safe place where the problem can be checked.

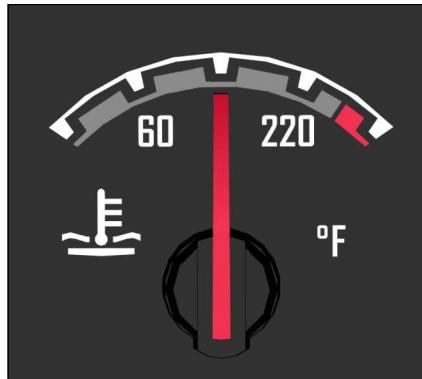

W3133363

## Engine Oil Pressure Gauge

Indicates engine oil pressure. When the engine oil pressure is too low, the red STOP tell-tale illuminates and the buzzer will sound. If the engine oil pressure becomes low, the engine is at risk. Bring the vehicle to a safe stop where the problem can be checked.



### DANGER

Failure to take necessary action when the STOP tell-tale is on can ultimately result in automatic engine shutdown and loss of power steering assist. Vehicle crash can occur, resulting in personal injury or death.



W3133319

Stop Tell-Tale

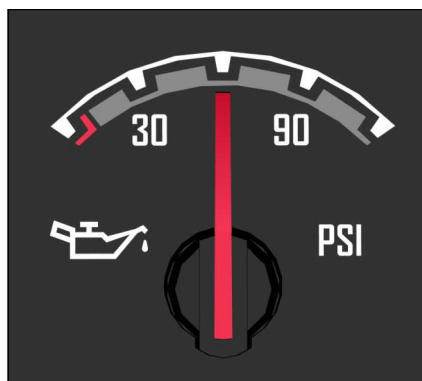

W3133362

## Aftertreatment DEF Gauge

Indicates the amount of Diesel Exhaust Fluid (DEF) in the tank.



W3133364

## Fuel Gauge

Indicates the fuel level. The fuel gauge is connected to the fuel sensor unit in the fuel tank. There is only one sensor even if the vehicle is equipped with dual tanks.

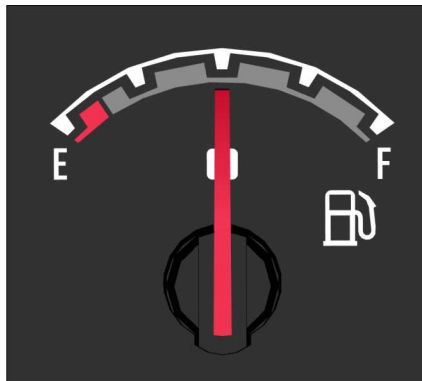

W3133365

## Secondary Brake Air Pressure Gauge

The secondary brake air pressure gauge is connected to the front circuit tank via sensors mounted on the passthrough wall. The front and rear air gauges should register equal air pressure. By observing the gauge pointers, the operator can detect a pressure drop if an air leak develops and can readily identify the circuit affected.



### DANGER

Failure to observe these precautions can result in the loss of braking performance. This can lead to a vehicle accident, which can result in personal injury or death.



W3133366

## Primary Brake Air Pressure Gauge

The primary brake air pressure gauge is connected to the rear circuit tank via sensors mounted on the passthrough wall. The front and rear air gauges should register equal air pressure. By observing the gauge pointers, the operator can detect a pressure drop if an air leak develops and can readily identify the circuit affected.



### DANGER

Failure to observe these precautions can result in the loss of braking performance. This can lead to a vehicle accident, which can result in personal injury or death.

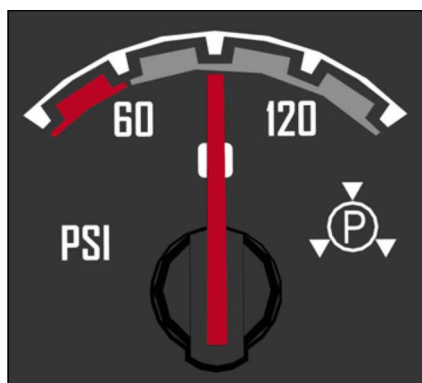

W3133367

## Secondary Gauges

On certain vehicles, secondary gauges are included. These gauges are located to the right of the steering wheel, above the main switch location.

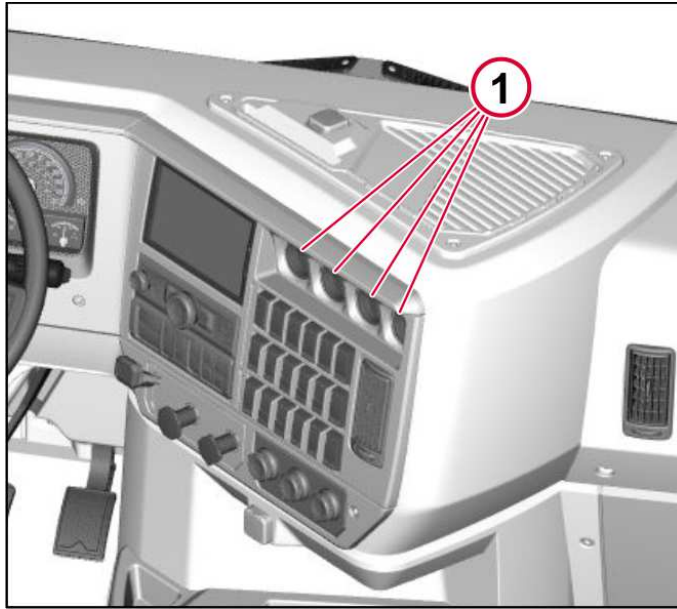

W3133368

1. Secondary Gauges

### Notes

---

---

---

---

---

# Tell-Tales

A tell-tale is a display that indicates the actuation of a device, a correct or defective condition, or a failure to function.











The operator should become familiar with these symbols in order to recognize and react (if necessary) to the indicated condition. Tell-tale symbols are shown in the instrument panel cluster.

# Colors











To promote visual recognition internationally, specific colors for tell-tales have been established. Unless governmental regulations (in the area where the vehicle is to be used) or engineering directives specify otherwise, the standard colors are:

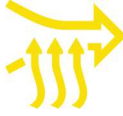





- **Steady Blue** — high-beam headlights
- **Flashing Green** — turn signals
- **Flashing Red** — hazard condition involving the safety of personnel
- **Steady Green** — system in operation
- **Steady Red** — warning, immediate action required
- **Amber** — early warning, such as low fuel or Anti-Lock Brake System (ABS) malfunction

# Alarm, Check and Information Symbols

Number	Symbols	Meaning
1	 W3133317	Malfunction Indicator Lamp
2	 W3133318	Hill Assist Indicator
3	 W3133319	Stop
4	 W3133320	Interaxle lock
5	 W3133321	Differential lock
6	 W3133322	Turn Signal Indicator
7	 W3133324	Parking Brake engaged
8	 W3133-326	Safety Belts Reminder
9	 W3133327	Aftertreatment DPF Regeneration
10	 W3133328	Aftertreatment High Exhaust System Temperature



Number	Symbols	Meaning
11	 W313-3329	ABS Malfunction Trailer
12	 W3133330	ABS Malfunction Tractor
13	 W3133331	Preheating Active or Preheating Fault
14	 W3133333	High Beam Indicator
15	 W3133334	Aftertreatment DEF Tank Low Indicator
16	 W313333-5	Check Indicator
17	 W3133336	Light Indicator
18	 W3133337	Tractor Control System (TCS) Indicator
19	 W3-133-338	Lane Departure Warning System (LDWS) Indicator
20		Power Take-off (PTO) Indicator

Number	Symbols	Meaning
	W3133339	
21	 W31-333-40	Electronic Stability Control (ESC) Indicator
22	 W3133341	Daytime Running Light (DRL) Indicator
23	 W3133342	Lane Changing System (LCS) Indicator
24	 W3133343	Airbag Indicator
25	 W3133344	Tire Pressure Monitoring System (TPMS) Indicator
26	 W31333-45	Automatic Traction Control (ATC)

# Warning Indicator Light Panel

## 1. Malfunction Indicator Lamp

Malfunction Indicator Lamp indicates government Regulation On Board Diagnostics (OBD) faults.

## 2. Hill Assist Indicator

Indicates hill assist is active.

## 3. Stop Tell-Tale

Illuminates when conditions require the driver to stop the vehicle. This usually occurs when vehicle conditions fall below designated standards for operation.



### **DANGER**

Failure to take necessary action when the STOP tell-tale is on can ultimately result in automatic engine shutdown and loss of power steering assist. Vehicle crash can occur, resulting in personal injury or death.

## 4. Interaxle Lock

Illuminates when interaxle lock is engaged.

## 5. Differential Lock

Illuminates when differential lock is engaged.

## 6. Turn Signal Indicator

Flashes when turn signals are active.

## 7. Parking Brake Engaged

Indicates parking brake is engaged.

## 8. Safety Belt Reminder

Indicates safety belt needs to be fastened.

## 9. Aftertreatment DPF Regeneration

Indicates aftertreatments DPF regeneration is required.

## 10. High Exhaust System Temperature (HEST) Indicator

The HEST Indicator illuminates when the exhaust temperature reaches 300° C (572° F) and the regeneration process begins. When the regeneration process is completed, the engine should be allowed to run until the HEST indicator shuts off.

During regeneration while the vehicle is moving, the HEST indicator will only illuminate when vehicle speed is less than 8 kph (5 mph). During a parked regeneration, the HEST indicator will turn off when regeneration is complete and the exhaust temperature has returned to a normal temperature.

## **11. ABS Trailer Malfunction**

Indicates a problem being reported by the Trailer ABS System.

## **12. ABS Tractor Malfunction**

Indicates a problem being reported by the Tractor ABS System.

## **13. Preheating Active**

Indicates that preheating is active.

## **14. High Beam**

Illuminates when high beam lights are engaged.

## **15. Aftertreatment DEF Tank Low**

Illuminates when the fluid level is low. It also Flashes when the level becomes critically low.

## **16. Check Indicator**

Illuminates when there is an engine or aftertreatment system issue.

## **17. Light Indicator**

Illuminates when there is a lighting system error.

## **18. Traction Control System (TCS) Indicator**

Indicates that the TCS is active.

## **19. Lane Departure Warning System (LDWS) Indicator**

Indicates that the LDWS is off.

## **20. Power Take-off (PTO) Indicator**

Indicates that the PTO is active.

## **21. Electronic Stability Control (ESC) Indicator**

Indicates that the ESC system is active.

## **22. Daytime Running Light (DRL) Indicator**

Indicates that the DRLs are active.

## **23. Lane Change System (LCS) Indicator**

Indicates that the LCS is off or disabled.

## 24. Airbag Indicator

Indicates that there is an airbag error. Maintenance is required.

## 25. Tire Pressure Monitoring System (TPMS) Indicator

Indicates that there is an issue with the vehicle's tire pressure. Maintenance is required.

## 26. Automatic Traction Control (ATC) Indicator

Indicates that the vehicle is losing traction and the ATC is engaging.

## Dash Switches

### General



Switches that may be fitted in your vehicle are on the following pages. The available switches in your particular vehicle are dependent on the vehicle's equipment.

### Movable Switches

The location of the majority of the switches can be easily adapted to your requirements. A few switches cannot be moved for safety reasons. Contact an authorized dealership for more information.

### Switch Styles

There are three types of switches that are used on the dash panel.

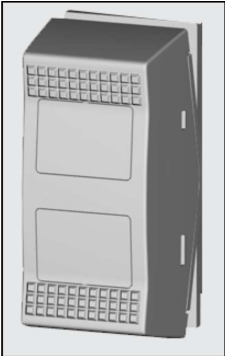
Locking	Standard	BodyBuilder Assignable
 <p>W3133393</p>	 <p>W3133394</p>	 <p>W3133395</p>

# Switch Package AUXSW-6B Assignable Body Builder Dash Mounted Rocker Switches

(3) 20A, Ignition Powered, Latching On / Off (Part Number: 22396611)

(2) 15A, Ignition Powered, Latching On / Off (Part Number: 23239141)

(1) 20A, Ignition Powered, Momentary On / Off (EAXD4X) (Part Number: 22392311)

Affects: Conventional Models

When switch package option AUXSW-6B is ordered, switches will be in position #7, #12, #13, #16, #17, and #18.

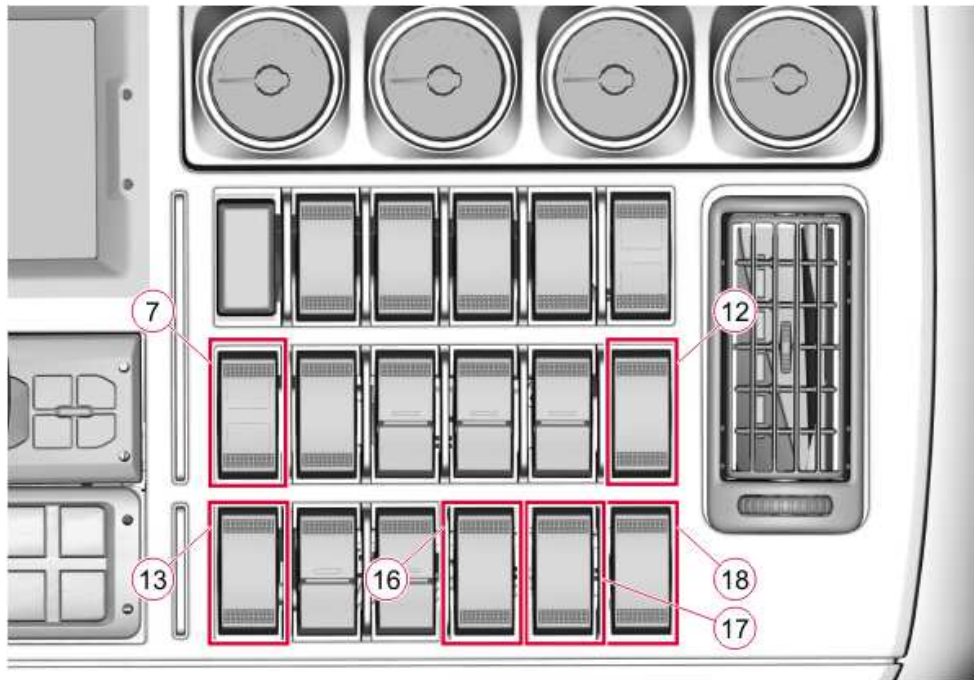

W3133963

AUXSW-6B switch package is highlighted in red. The above image represents the standard installation locations. Switch locations can change based on other equipment ordered and assembly procedures.

Number	Description
7	20A, Ignition Powered, Momentary On / Off (EAXD4X)
12	15A, Ignition Powered, Latching On / Off
13	15A, Ignition Powered, Latching On / Off
16	20A, Ignition Powered, Latching On / Off
17	20A, Ignition Powered, Latching On / Off
18	20A, Ignition Powered, Latching On / Off

# Lens Kit for Assignable Body Builder Switches: Part # 22392309



W3133399

# TE/MRU Dash Panel

## Dash Overview

Before driving this vehicle, locate the instruments and controls, and become familiar with their operation. After starting and when driving, ensure that the instrument readings are normal.

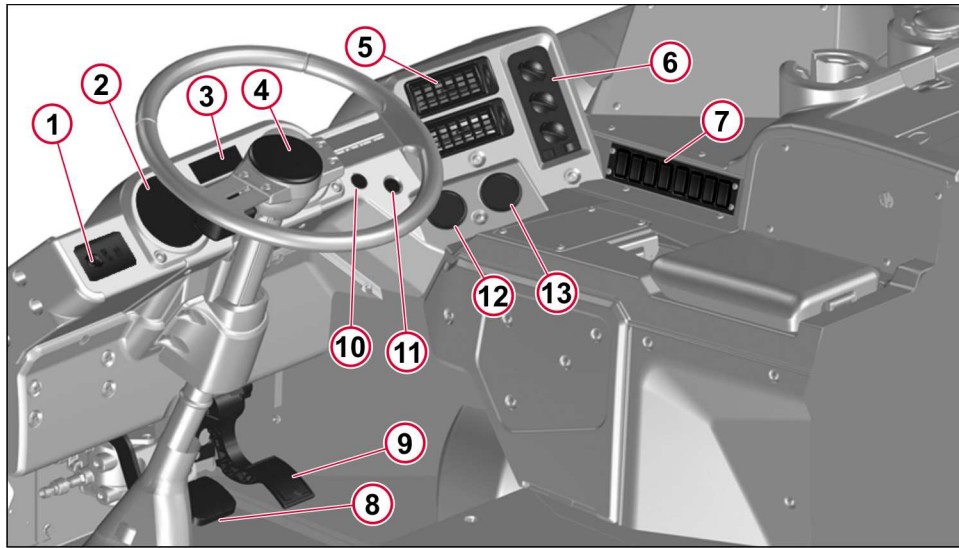

W2122037

1. Light Control Panel	6. Climate Control Panel	11. Parking Brake
2. Tachometer	7. Switch Locations	12. Air Pressure Gauge
3. Tell-Tale Display	8. Brake Pedal	13. Fuel Gauge
4. Electric Horn	9. Accelerator Pedal	
5. Vent	10. Ignition	

# Gauge Layout

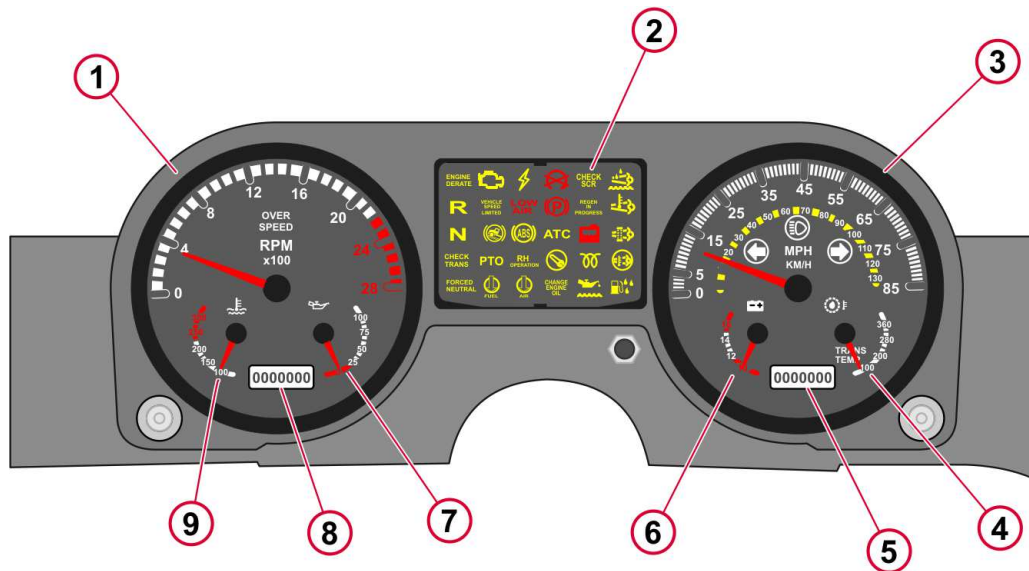

W3133390

1. Tachometer	4. Transmission Oil Temperature Gauge	7. Engine Oil Pressure Gauge
2. Warning Indicator Lamps	5. Odometer / Trip Counter	8. Hour Meter
3. Speedometer	6. Voltmeter	9. Engine Coolant Temperature Gauge

## 1. Tachometer

Indicates engine speed in revolutions per minute (RPM). Tachometer readings should be used as a guide for shifting, as well as to prevent engine damage due to over speed.

## 2. Warning Indicator Lamps

Illuminates if a status or fault indicator condition is active.

## 3. Speedometer

Indicates road speed in miles and/or kilometers per hour.

## 4. Transmission Oil Temperature Gauge

Indicates transmission oil temperature.

## 5. Odometer

Measures the distance traveled by the vehicle.

## 6. Voltmeter

Indicates the surface charge of the battery with the engine NOT running (and the ignition ON). Indicates the condition of charging system with the engine running.



## 7. Engine Oil Pressure Gauge

Indicates engine oil pressure. The normal operating oil pressure for a Mack MP7™ engine (at governed speed) is 275.8 – 620.5 kPa (40 – 90 psi). At idling speed, the oil pressure should be 275.8 – 413.9 kPa (40 – 60 psi). Should the oil pressure drop suddenly from the normal readings, stop the engine immediately and determine the cause.

## 8. Hour Meter

Indicates hours of engine operation. Hours of operation should be used as a guide for certain engine or PTO maintenance operations.

## 9. Engine Coolant Temperature Gauge

Indicates the temperature of the engine coolant. The normal operating temperature for a Mack MP7™ engine is 77-107° C (170–225° F). The driver will receive a warning if the coolant temperature reaches 106° C (223° F) and engine shutdown will occur at 108° C (227° F) if the engine coolant temperature shut down option is enabled.



### CAUTION

Avoid component damage, coolant temperature must NOT exceed 107° C (225° F).

## Right Hand Gauges

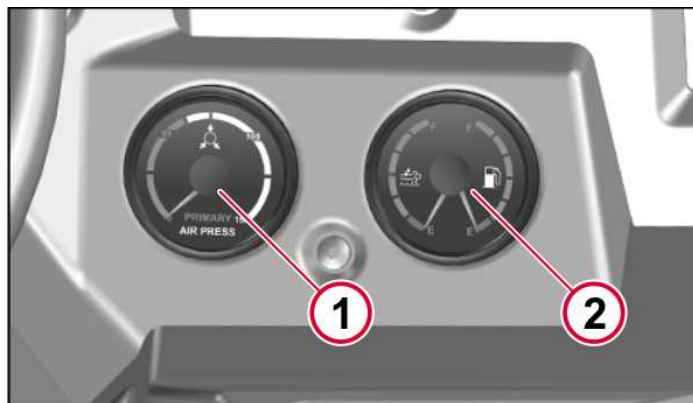

W3133391

### 1. Air Pressure Gauge

Indicates air pressure in the air brake system. The normal operating air pressure is 759 kPa - 897 kPa (110 psi - 130 psi). If pressure drops below 75 psi ( $\pm 5$  psi), the warning buzzer and warning light will go on. Determine the cause of failure before proceeding.

### 2. Fuel/DEF Gauge

Registers the fuel and DEF levels in the supply tank(s).

# Tell-Tales

A tell-tale is a display that indicates the actuation of a device, a correct or defective condition, or a failure to function.

The operator should become familiar with these symbols in order to recognize and react (if necessary) to the indicated condition. Tell-tale symbols are shown in the instrument panel cluster.

# Colors

To promote visual recognition internationally, specific colors for tell-tales have been established. Unless governmental regulations (in the area where the vehicle is to be used) or engineering directives specify otherwise, the standard colors are:







- **Blue** — high-beam headlights/engine maintenance
- **Flashing Green** — turn signals
- **Flashing Red** — hazard condition involving the safety of personnel
- **Steady Green** — system in operation
- **Steady Red** — warning, immediate action required
- **Amber** — early warning, such as low fuel or Anti-Lock Brake System (ABS) malfunction



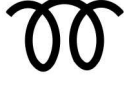









## CAUTION

The maximum safe oil temperature for Mack transmissions is 121° C (250° F) for mineral-based oil, or 148° C (300° F) for synthetic oil. Continued operation with oil above this temperature will cause rapid deterioration of the oil's lubricating properties and is NOT recommended.

# Alarm, Check and Information Symbols

Number	Symbols	Meaning
1	 W3133369	Malfunction Indicator Lamp
2	 W3133370	Wait to Start
3	 W3133371	Electronic Malfunction Indicator
4	 W3133372	Engine Shut-down Indicator
5	 W3133373	Aftertreatment DEF Tank Low Level Indicator
6	 W3133374	Grade Gripper
7	 W3133375	Anti-Brake System Indicator (ABS)
8	 W3133376	Turn Signal Indicator
9	<b>R</b>	Reverse

Number	Symbols	Meaning
10	<b>N</b>	Neutral
11	<b>PTO</b>	Power Take Off
12	<b>ATC</b>	Indicates ATC Malfunction
13	<b>Low Air</b>	Indicates low air pressure
14	 W3133377	High Beam Indicator
15	 W3133507	Parking Brake engaged
16	 W3133379	Aftertreatment DPF Regeneration
17	<b>CHECK SCR</b>	Check SCR Indicator
18	<b>ENGINE DERATE</b>	Engine Derate Indicator
19	<b>Vehicle Speed Limited</b>	Indicates limits in speed
20	<b>RH Operation</b>	Right Hand Operation
21	<b>Forced Neutral</b>	Indicates vehicle is in forced neutral
22	<b>Change Engine Oil</b>	Indicates engine oil change is needed
23	 W3133380	Road Stability Advantage
24	 W3133381	HEST Indicator

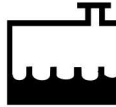
Number	Symbols	Meaning
25	 W3133384	Maintenance Due Indicator
26	 W3133385	Fuel Filter Restriction
27	 W3133386	Air Filter Restriction
28	 W3133387	Engine Oil Level
29	<b>Check Trans</b>	Indicates Transmission Malfunction
30	<b>Regen In Progress</b>	Regeneration
31	 W3133388	Aftertreatment DPF Regeneration
32	 W3133389	Low Coolant Level Indicator

# Warning Indicator Light Panel

## 1. Malfunction Indicator Lamp

Malfunction Indicator Lamp (MIL) indicates On Board Diagnostics (OBD) faults. Lamp remains active after repair until system operation confirms repair.

## 2. Wait to Start

Indicates that the intake pre-heat is enabled. Wait to start engine until light goes out.

## 3. Electronic Malfunction Indicator

Illuminates when an electronic malfunction is detected.

## 4. Engine Malfunction Indicator

Indicates that occurrence of a condition which is required that the engine be shut down (i.e., low coolant level, low oil pressure or high coolant temperature). If the engine shutdown feature is enabled, the operator has about 15 seconds after the light goes on to pull to the side of the road before the engine shuts off. If the engine shutdown feature is disabled, the indicator will function as a warning light but the engine will not shutdown.

## 5. Aftertreatment DEF Tank Low Indicator

Illuminates when the fluid level is low. It also Flashes when the level becomes critically low.

## 6. Grade Gripper

Grade Gripper provides anti-roll back assistance during the transition from a stopped position to starting on a grade.

## 7. Anti—Lock Brake System (ABS) Indicator

Indicates an ABS malfunction. Also illuminates momentarily as a bulb check when the ignition is turned on. If the light turns on and stays on, a malfunction is indicated. If the light does not turn on when the ignition is turned on, the bulb and/or the power source may be defective.

**Note:** When an ABS malfunction is detected, anti-lock braking in the affected wheel will be disabled and normal braking will return; the other wheels will retain anti-lock braking.

## 8. Turn Signal Indicators

Flashes when turn signals are activated.

## 9. Reverse Indicator

Indicates that the transmission is in Reverse.

## 10. Neutral Indicator

Indicates that the transmission is in Neutral.

## 11. Power Take-Off

Indicates PTO.

## **12. Automatic Traction Control (ATC) Indicator**

Indicates that ATC is operating.

## **13. Low Air Pressure Warning Indicator**

Indicates low air pressure in the air brake system(s). This feature may also come with a buzzer.

## **14. High Beam Indicator**

Indicates that high beams are on.

## **15. Parking Brake Indicator**

Indicates that the parking brake is engaged.

## **16. Aftertreatment DPF Regeneration Required Icon**

Flashes when the Diesel Particulate Filter (DPF) is becoming full / overfull and regeneration is needed.

## **17. Check SCR**

Illuminates if a DPF Quality or Tampering fault code is active.

## **18. Engine Derate**

Illuminates when the engine is in light or heavy DPF / DEF inducement or if derate > 20%.

## **19. Vehicle Speed Limited**

Illuminates if speed limited via the DEF 5 mph inducement of DPF VSL function.

## **20. Right-Hand Operation**

Indicates that a right-hand drive mode has been enabled.

## **21. Forced Neutral**

Illuminates when PTO is engaged and the vehicle is not moving.

## **22. Change Engine Oil**

If illuminated, immediately check the level of the engine oil.

## **23. Road Stability Advantage (RSA)**

Blinks whenever the system is active. The tell-tale is constantly illuminated if there is a system error.

## 24. High Exhaust System Temperature (HEST) Indicator

The HEST Indicator illuminates when the exhaust temperature reaches 300° C (572° F) and the regeneration process begins. When the regeneration process is completed, the engine should be allowed to run until the HEST indicator shuts off.

During regeneration while the vehicle is moving, the HEST indicator will only illuminate when vehicle speed is less than 8 kph (5 mph). During a parked regeneration, the HEST indicator will turn off when regeneration is complete and the exhaust temperature has returned to a normal temperature.

## 25. Maintenance Due Indicator

Indicates that a maintenance alert has been issued (maintenance is due).

## 26. Fuel Filter Restriction

Illuminates when the fuel filter restriction limit is reached.

## 27. Air Filter Restriction

Illuminates when the air filter restriction limit is reached.

## 28. Engine Oil Level

If illuminated, immediately check the level of your engine oil.

## 29. Check Trans

Indicates transmission malfunction. Only present on vehicle equipped with automatic transmission.

## 30. Regen In Progress

Indicates regeneration is in progress.

## 31. Aftertreatment DPF Regeneration Required Icon

Illuminates when the inhibit switch is turned on. It will allow the driver to know that the switch is in the inhibit position and a regeneration will not occur.

## 32. Low Coolant Level Indicator

Illuminates when the coolant level in the coolant surge tank is below the specified level. Stop and add coolant.

# LR DASH PANEL

## Overview of Instruments

Before driving this vehicle, locate the instruments and controls, and become familiar with their operation. After starting and when driving, ensure that the instrument readings are normal.

## Dash Overview

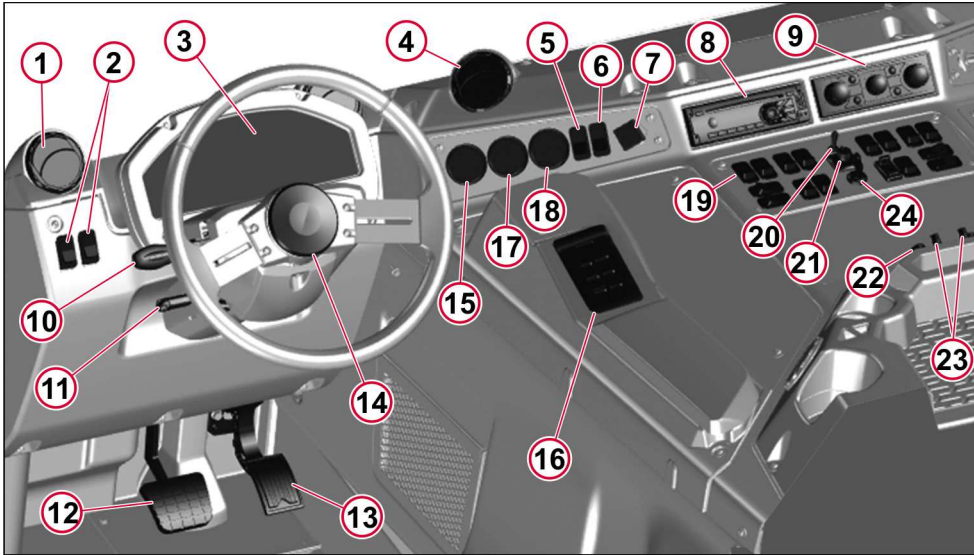

W2122036

1. Air Vent	9. Climate Control Panel	17. Transmission Oil Temperature
2. Enter / Escape for Driver Information Display (DID)	10. Turn Signal	18. Fuel Gauge / Diesel Exhaust Fluid (DEF) Gauge
3. Cluster	11. Telescopic Steering Adjust Lever	19. Switch Location
4. Air Vent	12. Brake Pedal	20. Operating Position Selector
5. Cruise Control	13. Accelerator Pedal	21. Mirror Adjustment Knob
6. Speed Control	14. Electric Horn	22. Auxiliary Lighter
7. Park Brake	15. Manifold Pressure or Rear Axle Gauge	23. CB Radio Connector (Positive and Negative)
8. Audio	16. Gear Selector	24. Ignition



# Instrument Panel Gauge Layout

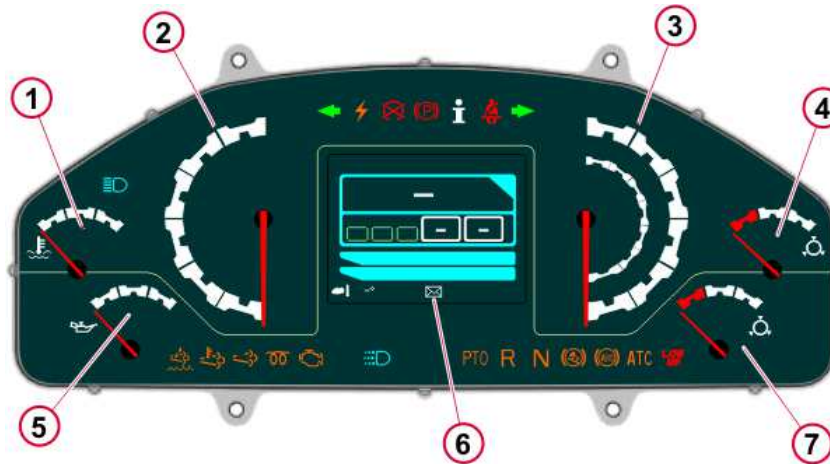

W3133392

1. Engine Coolant
2. Tachometer
3. Speedometer
4. Primary Air Pressure
5. Engine Oil Pressure
6. Drivers Information Display (DID)
7. Secondary Air Pressure

## Tell-Tales

A tell-tale is a display that indicates the actuation of a device, a correct or defective condition, or a failure to function.









The operator should become familiar with these symbols in order to recognize and react (if necessary) to the indicated condition. Tell-tale symbols are shown in the instrument panel cluster.







## Colors

To promote visual recognition internationally, specific colors for tell-tales have been established. Unless governmental regulations (in the area where the vehicle is to be used) or engineering directives specify otherwise, the standard colors are:

- **Blue** — high-beam headlights/engine maintenance
- **Flashing Green** — turn signals
- **Flashing Red** — hazard condition involving the safety of personnel
- **Steady Green** — system in operation
- **Steady Red** — warning, immediate action required
- **Amber** — early warning, such as low fuel or Anti-Lock Brake System (ABS) malfunction

# Alarm, Check and Information Symbols

Number	Symbols	Meaning
1	 W3133369	Malfunction Indicator Lamp
2	 W3133370	Wait to Start
3	 W3133371	Electronic Malfunction Indicator
4	 W3133372	Engine Shut-down Indicator
5	 W3133373	Aftertreatment DEF Tank Low Level Indicator
6	 W3133374	Grade Gripper
7	 W3133375	Anti-Brake System Indicator (ABS)
8	 W3133376	Turn Signal Indicator
9	<b>R</b>	Reverse
10	<b>N</b>	Neutral

Number	Symbols	Meaning
11	<b>PTO</b>	Power Take Off
12	<b>ATC</b>	Indicates ATC Malfunction
13	<b>Low Air</b>	Indicates low air pressure
14	<b>BRAKE</b>	Emergency Brake Indicator
15	 W3133378	Information Indicator
16	 W3133377	High Beam Indicator
17	 W3133507	Parking Brake Engaged
18	 W3133382	Safety Belts Reminder
19	 W3133379	Aftertreatment DPF Regeneration
20	 W3133381	Aftertreatment High Exhaust System Temperature

# Warning Indicator Light Panel

## 1. Malfunction Indicator Lamp

Malfunction Indicator Lamp (MIL) indicates On Board Diagnostics (OBD) faults. Lamp remains active after repair until system operation confirms repair.

## 2. Wait to Start

Indicates that the intake pre-heat is enabled. Wait to start engine until light goes out.

## 3. Electronic Malfunction Indicator

Illuminates when an electronic malfunction is detected.

## 4. Engine Shutdown Indicator

Indicates that occurrence of a condition which requires that the engine be shut down (i.e., low coolant level, low oil pressure or high coolant temperature). If the engine shutdown feature is enabled, the operator has about 15 seconds after the light goes on to pull to the side of the road before the engine shuts off. If the engine shutdown feature is disabled, the indicator will function as a warning light but the engine will not shutdown.

## 5. Aftertreatment DEF Tank Low Indicator

Illuminates when the fluid level is low. It also Flashes when the level becomes critically low.

## 6. Grade Gripper

Grade Gripper provides anti-roll back assistance during the transition from a stopped position to starting on a grade.

## 7. Anti-Lock Brake System (ABS) Indicator

Indicates an ABS malfunction. Also illuminates momentarily as a bulb check when the ignition is turned on. If the light turns on and stays on, a malfunction is indicated. If the light does not turn on when the ignition is turned on, the bulb and/or the power source may be defective.

**Note:** When an ABS malfunction is detected, anti-lock braking in the affected wheel will be disabled and normal braking will return; the other wheels will retain anti-lock braking.

## 8. Turn Signal Indicators

Flashes when turn signals are activated.

## 9. Reverse Indicator

Indicates that the transmission is in Reverse.

## 10. Neutral Indicator

Indicates that the transmission is in Neutral.

## **11. Power Take-Off**

Indicates PTO.

## **12. Automatic Traction Control (ATC) Indicator**

Indicates that ATC is operating.

## **13. Low Air Pressure Warning Indicator**

Indicates low air pressure in the air brake system(s). This feature may also come with a buzzer.

## **14. Emergency Brake**

Indicates emergency brake is engaged.

## **15. Information Indicator**

Indicates a malfunction. See a Mack technician if illuminated.

## **16. High Beam Indicator**

Indicates that high beams are on.

## **17. Parking Brake Indicator**

Indicates that the parking brake is engaged.

## **18. Safety Belt Indicator**

Indicates that the safety belt needs to be fastened.

## **19. Aftertreatment DPF Regeneration**

Illuminates when the inhibit switch is turned on. It notifies the driver when the switch is in inhibit position and regeneration will not occur.

## **20. Aftertreatment High Exhaust System Temperature**

Indicates high exhaust temperature.

# PTO



## DANGER

A Rotating PTO shaft can snag clothes, hands, etc., causing severe personal injury or death. To avoid injury or death:

- Do NOT go near rotating shafts when the engine is running.
- STOP the engine before attempting to work on a PTO, its controls or related equipment.



## CAUTION

It is important to only engage the switch when the PTO is required. Leaving the PTO pump engaged when not needed can lead to poor performance and pump damage.

**Note:** Some PTOs can not be operated while driving the vehicle. To do so would cause component damage. To avoid component damage, contact a certified dealer to confirm if the vehicle's PTO can be used while driving.

A Power Take-Off (PTO) is a device that transfers power from the engine to another piece of equipment attached to the vehicle. Some examples include cement mixers and the compactor on a garbage vehicle.

A maximum of four PTOs can be operated in unison. One PTO is preset as a priority component. The remaining PTOs are preset as secondary, third or fourth in priority. The priority settings are dependent on the PTO preset arrangement and the number of PTOs available.

There are three basic types of PTOs available: engine-mounted, transmission-mounted, and drive shaft-mounted.

The **engine-mounted PTO** is direct-mounted to the engine and is engaged with a bypass valve operated by an internal switch.

The **transmission-mounted PTO** is clutch-dependent, which means that operation can be regulated by depressing or releasing the clutch pedal. For *mDrive* transmissions, this is controlled by the Transmission Electronic Control Unit (TECU). If the vehicle has an automatic transmission the PTO operation and speed adjustment is controlled via an interior switch.

Depending on customer specification, some transmission-mounted PTOs are not operable when driving the vehicle.

The **drive shaft-mounted PTO** consists of an additional gearbox that divides the drive shaft into two shafts. One shaft drives the vehicle's axle. The other shaft drives the PTO.

When the PTO is engaged, the PTO tell-tale illuminates in the instrument cluster.

**PTO**

W3133339

PTO Tell-Tale

Use the following switch to activate/deactivate the PTO.



W3133396

PTO Switch

**For manual transmissions:**

1. From a parked location, depress the clutch pedal.
2. Engage the PTO by pressing the PTO switch. Press the locking tab and at the same time depress the main part of the switch.
3. Release the clutch pedal to start the PTO.

**For automatic transmissions:**

1. Engage the PTO by pressing the PTO switch. Press the locking tab and at the same time depress the main part of the switch.

The PTO engages.

## Engine-Mounted PTO

Prior to engaging the PTO, stop the vehicle. Then run the engine at low idle or at a low speed.

1. Engage the PTO by pressing the PTO switch. Press the locking tab and at the same time depress the main part of the switch.

The PTO is now in operation and hydraulic flow is regulated by the engine speed.

## PTO Speed Adjustment

For the PTO speed adjustment to function, the Cruise Control and PTO must be activated. If the PTO can be activated while driving the vehicle, the vehicle speed must be under approximately 8 Km/h (5 mph).

### To set the engine speed:

1. Press the Cruise Control / Speed Control Switch to the ON position. This switch can be located on the steering wheel or on the dash of the vehicle.
2. Press the PTO switch to the ON position.

The PTO is now active. The PTO revolutions per minute (RPM) automatically adjusts to the preset PTO speed.

For vehicles with the cruise control switches in the steering wheel or on the dash:

3. Press and hold the RESUME / SET or ACCEL / DECEL button to increase or decrease PTO engine speed. Then press SET to have the PTO maintain the desired speed.

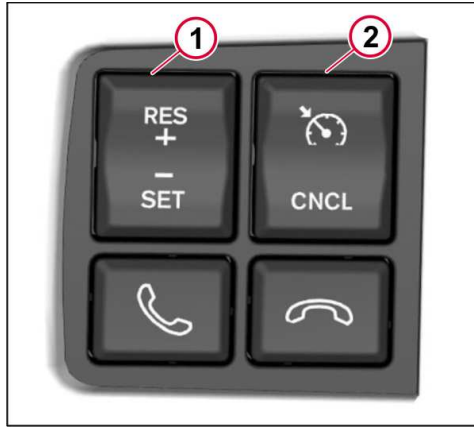

W3133397

1. Cruise Control Resume / Set Steering Wheel Switch
2. Cruise Control ON / OFF / Cancel Steering Wheel Switch



W3133398

Speed Control (Cruise Control) Switch



## VECU/BBM Locations

### VECU/Body Builder Module Location for AN / PI / GR

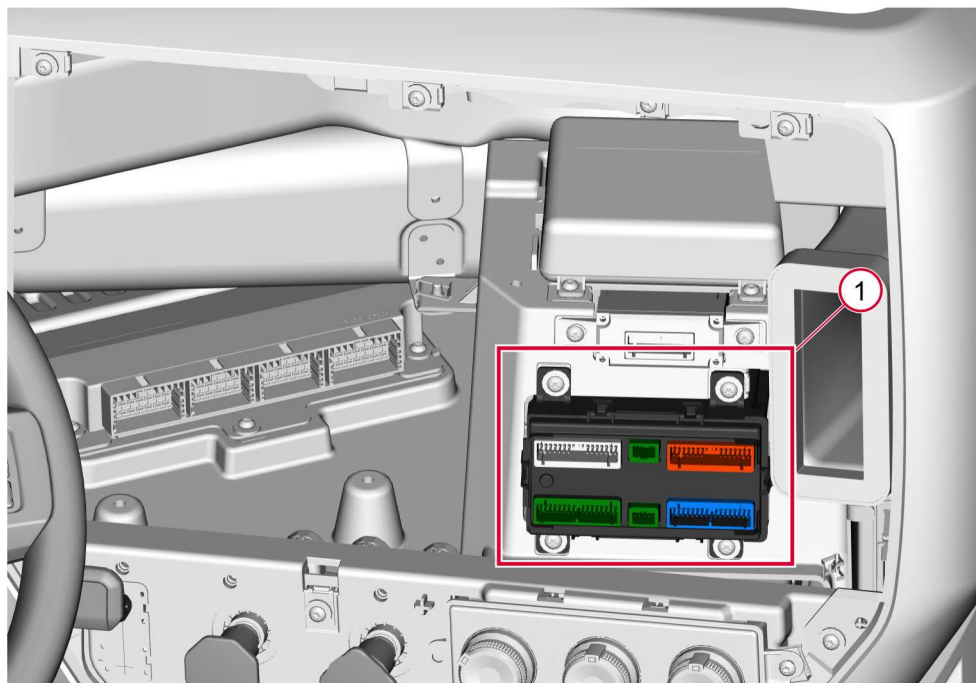

W3133540

1. Module location behind D Panel

### Body Builder Module Location for CHU / CXU / GU

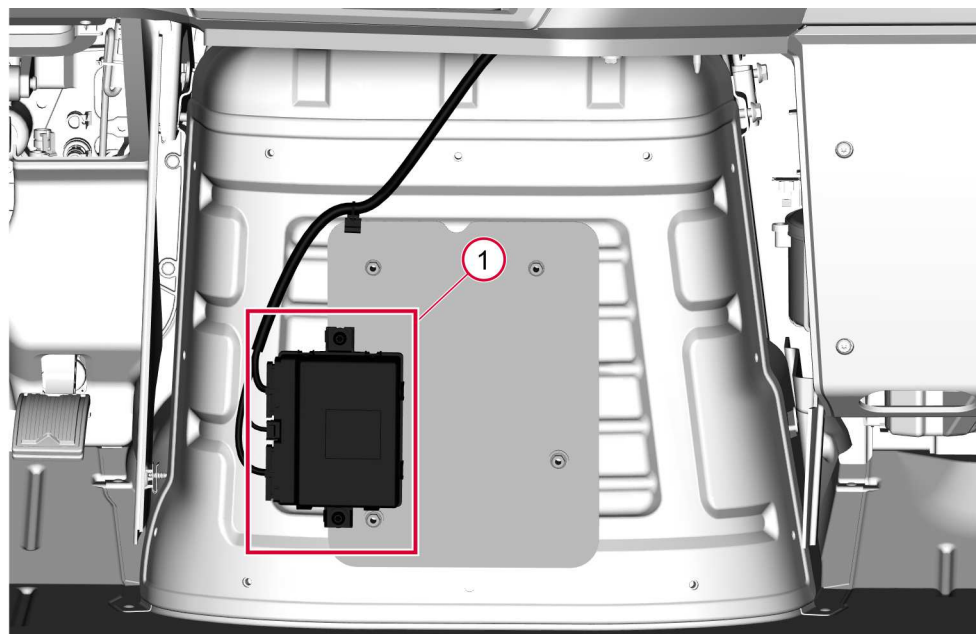

W3133541

1. Module location behind the engine cover

## VECU Location for CHU / CXU / GU / TD

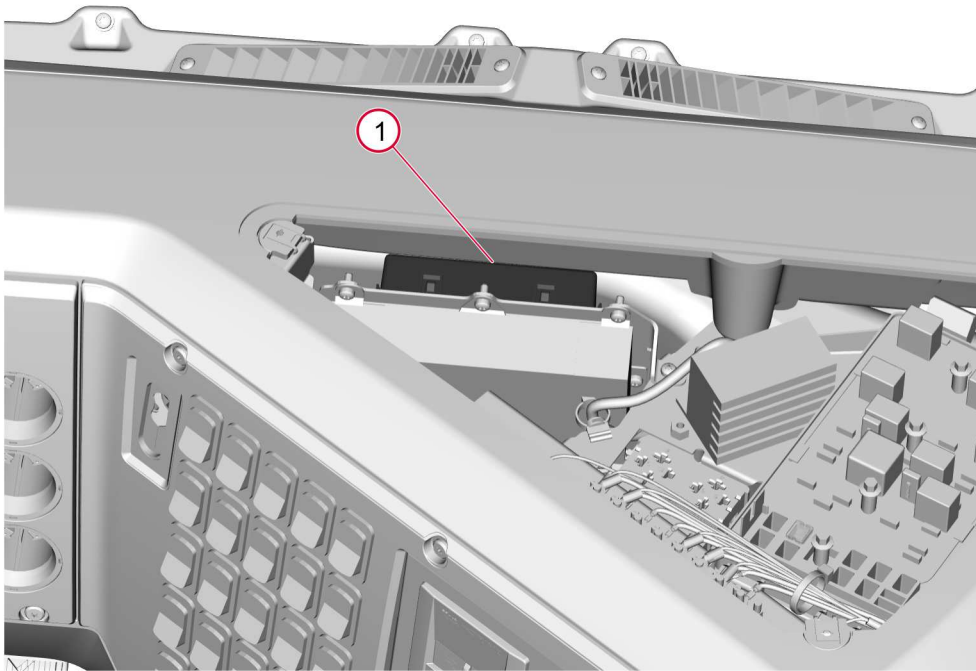

W3133542

1. VECU location behind D Panel

## VECU/Body Builders Module Location for TE / MRU

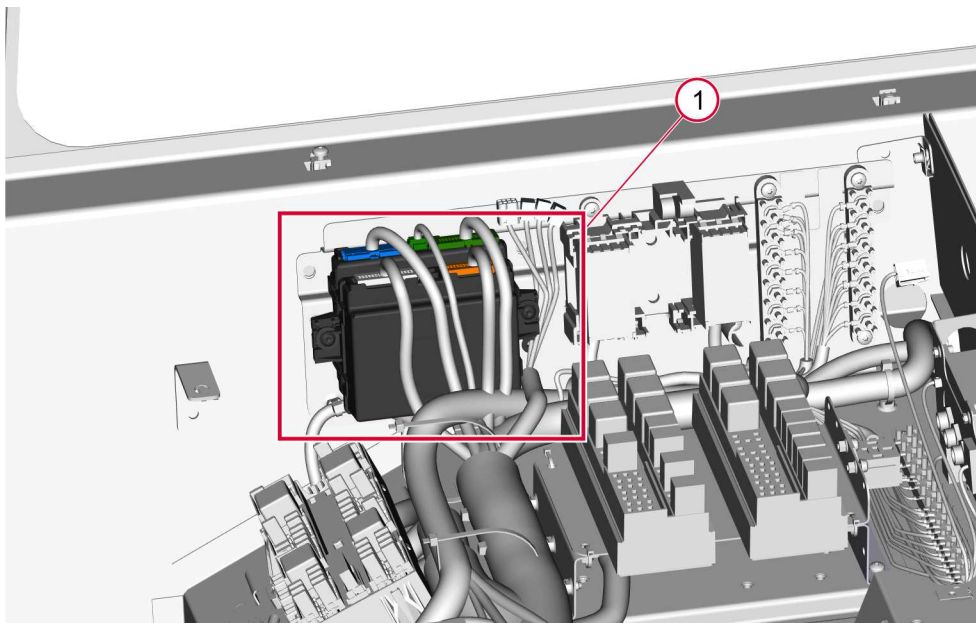

W3133543

1. Module location at rear of cab on engine tunnel

# VECU/Body Builders Module Location for LR

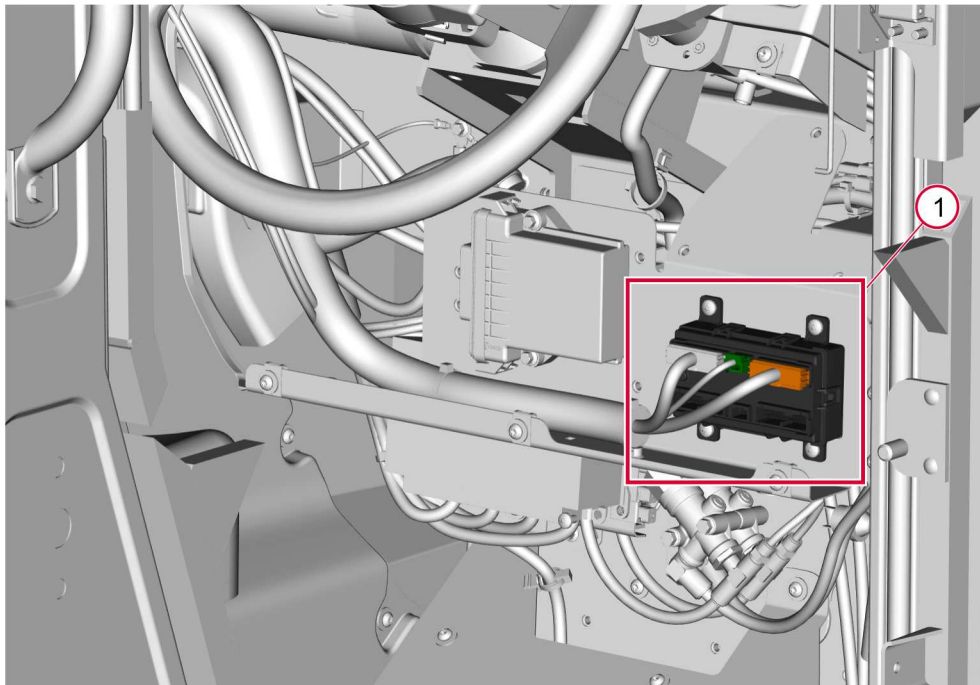

W3133544

1. Module location right hand side behind lower dash panel

## How to identify VECU and BBM (Vehicles Built From 1/1/2018 — Current)



**Note:** BBM will have the white and orange connector plug and the VECU will have the blue and green connector.

## How to identify VECU and BBM (Vehicles Built Before 12/31/2017)

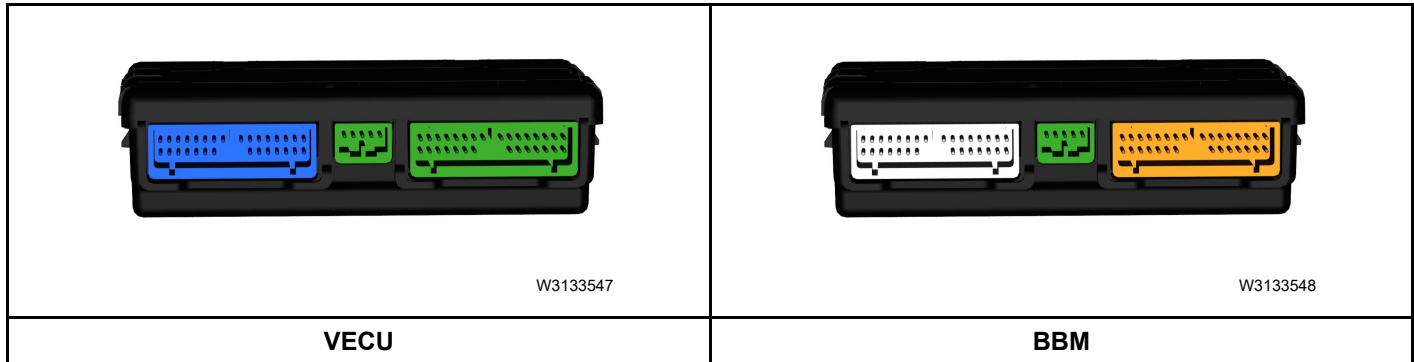

**Note:** BBM will have the white and orange connector plug and the VECU will have the blue and green connector.

### Notes

---

---

---

---

---

---

---

---